



WIRELESS TECHNOLOGIES

I POSITIONING

- I GNSS: GPS, GALILEO, BEIDOU, NAVIC, GLONASS
- I BANDS: L1, L2, L5, L6/E6, E1, E5, B2, B3, L-CORRECTIONS
- I CELLULAR & WIFI, BLUETOOTH, UWB

I CELLULAR: LTE CAT.1/1-bis, CAT.4, LTE-M, NB-IOT, GSM

- I 2G, 4G, 5G

I SATELLITE

- I ORBCOMM, 3GPP IOT-NTN/GEO/LEO
- I IRIDIUM

I WIFI, BLUETOOTH, THREAD, ZIGBEE, ISM

- I MATTER

I ANTENNAS & ACCESSORIES, SERVICES

WWW.MICRODIS.NET



NO MORE WIRES!

MICRODIS ELECTRONICS

acts as an independent high-tech distributor for many years, collecting experience in wireless communication devices. We offer not only the latest technology provided by well known suppliers, but also professional technical and commercial support, evaluation kits and reference designs, comprehensive deliveries including accessories such as antennas, connectors and adapters.

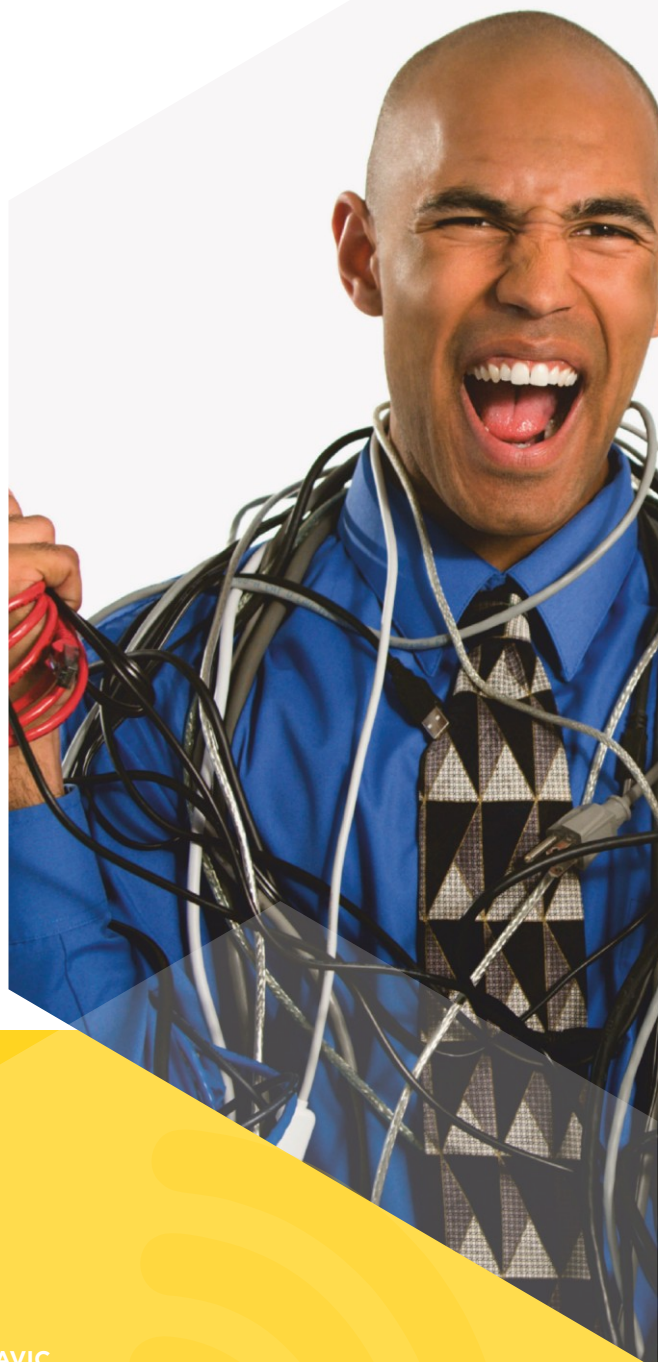

CONTENT

03	GNSS RECEIVERS: GPS, GALILEO, BEIDOU, QZSS, GLONASS, NAVIC
04	STANDARD PRECISION GNSS
05	NEW GNSS SOLUTIONS
05	PRECISE GNSS TIMING & FREQUENCY
06	HIGH PRECISION POSITIONING
08	DEAD RECKONING: GNSS + IMU NAVIGATION WITHOUT THE SKY VIEW
09	ASSISTNOW SERVICES FOR POSITIONING APPLICATIONS
10	DOUBLE CHIP MODULES
11	GNSS ANTENNA SELECTION GUIDE
12	POSITIONING TOOLS
13	CELLULAR FOR IOT: LTE CAT.1/1-bis, CAT.4, LTE-M, NB-IOT, SATELLITE IOT, 2G
13	LPWA BY U-BLOX
14	CELLULAR & SATELLITE IOT: LTE CAT.1/1-bis, CAT.4, LTE-M, NB-IOT, SATELLITE IOT, 2G
16	CAAS - COMPLETE IOT COMMUNICATION SOLUTION
17	UBXLIB: U-BLOX HOST LIBRARY
17	CELLULAR TOOLS
18	SMART AND EFFICIENT COOPERATION CELLULAR + GNSS
19	SHORT RANGE MODULES
19	BLUETOOTH & UWB INDOOR POSITIONING
20	BLUETOOTH STAND-ALONE MODULES
21	WI-FI, BLUETOOTH STAND-ALONE MODULES
22	WI-FI, BLUETOOTH HOST-BASED MODULES
23	SHORT RANGE TOOLS
23	U-BLOX WIRELESS SECURITY
24	HF CONNECTORS
25	GNSS ANTENNAS
26	CELLULAR ANTENNAS
27	ISM ANTENNAS



GNSS RECEIVERS

GPS, GALILEO, BEIDOU QZSS, GLONASS, NAVIC

L1, L2, L5, L6/E6, E1, E5, B1, B2, B3, L-corrections

FAST, MULTIBAND, POWER & COST optimised, MARKET PROVEN U-BLOX MODULES

We offer Swiss made receivers, produced by a well known company, u-blox, to ensure superb technical parameters, the highest reliability of the market proven products, but also additional features and market leading technologies.



u-bloxM10/F10, u-bloxF9/X20 - the latest GNSS technology, tailored towards applications requiring single- or multi-band, high sensitivity, fast first fix, low power and stable functionality under harsh conditions i.e. in vehicles or small, wearable devices.

- | Predefined profiles tune algorithms to specific application
- | Multiband versions for high precision also in the cities
- | True, dynamic sensitivity as high as -167dBm
- | Position accuracy (CEP, SBAS): 1.0m
- | High precision NEO/ZED-F9P, accuracy: 1cm
- | Low Power: <9 mW at 1Hz (MIA-M10C)
- | CloudLocate with additional up to 90% power saving
- | Assisted positioning service for all 4 GNSS
- | Sensors (IMU) for navigation without sky view (NEO-M9V/F10V, ZED-F9R)
- | Dedicated receivers for precise timing
- | Backward pin compatibility (ublox5/ublox6/ublox7/ubloxM8 generations)
- | Versions dedicated to cost sensitive applications
- | Easy to design, manufacture and integrate with antennas

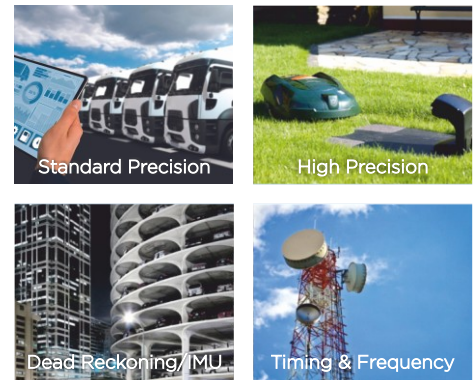

Feature	Description
Compatibility across technologies	Different technologies available at one, experienced manufacturer. Fast development of any application by u-blox familiar engineer. Standard GNSS, Centimetre-level GNSS, Single and Dual band GNSS, GNSS with sensors (IMU, Dead Reckoning), Receivers for satellite GNSS corrections, Precise timing and time synchronization based on GNSS.
Flexibility	Chipset, firmware and module - designed by u-blox for professional users. Rich of configuration options brings the most optimised fit to the particular use case.

POSITION BECAME CRITICAL INFORMATION, U-BLOX PROVIDES SOLUTION TO SECURE YOUR GNSS PLATFORM

Anti-Jamming detection, mitigation	Security: RF interference and jamming detection and reporting, including jammers. The best on the market jamming immunity. Mitigation using embedded filters, and IMU sensors (Dead Reckoning receivers).
Anti-Spoofing detection, mitigation/OSNMA	Security: spoofing detection and reporting. Spoofing is delivering a fake GNSS data to the receiver resulting in wrong position calculation. Spoofing attack can be mitigated by using an authenticated signal Galileo OSNMA, and IMU sensors (Dead Reckoning receivers).
Message integrity	Security: message authentication protects the communication from the receiver to the host, against sending fake GNSS time or position data to the host like by the "record and replay".
Device integrity	Security: receiver configuration can be locked by command to prevent unwanted modification. Secure boot of firmware downloaded from host or flash.



All wheels are round,
but are they all the same?



There are also many GNSS receivers...

STANDARD PRECISION GNSS

GPS, GALILEO, BEIDOU QZSS, GLONASS, NAVIC MODULES

Quality

u-blox places extraordinary emphasis on delivering high-quality products. The company's internal quality control process extends to all its manufacturing partners who comply to strict processes imposed by standards. GNSS and wireless products are designed and tested to operate in a wide variety of applications, including in vehicle usage.

Development and Reliability

u-blox, continuously introducing new products, takes special care of their existing customers. New families of the modules are designed to keep pin compatibility with the previous ones, which anyway will remain in production for a long time.



u-bloxM10: the latest, low power, accurate GNSS technology recommended for new designs (i.e. MAX-M10x, MIA-M10x).
u-bloxF10: dual band (L1, L5) core focused on reflections mitigation, for urban or indoor use cases (i.e. MAX-F10x, MIA-F10x, NEO-F10x).
u-bloxM9: designed by u-blox for high update rate (25Hz) or Dead Reckoning/IMU integration (i.e. NEO-M9x).
 Previous generations of GNSS receivers are maintained in production not to force to redesign (i.e. u-bloxM8).

Modules recommended for new designs are collected in the table below.

Model	Size [mm]	Vcc range [V]	GNSS bands	Additional: L-LNA, S-SAW, N-notch	Accuracy CEP50 [m]	Navigation update Multiconst./GPS only [Hz]	TCXO / Crystal	RTC crystal	PSM	Super low power CloudLocate	Super-S performance	Protection level	Data batching	Odometer	Spoofing detection, reporting/mitigation	Signed (protected) messages	Jamming detection, reporting	Device integrity	UART	DDC (I2C)	USB, SPI	Assisted GNSS Online, Offline, Autonomous	External interrupt Wakeup	Antenna supervisor
u-bloxM10																								
MIA-M10Q	4.5x4.5	1.76-3.6 ^{v1}	L1	NLS	1.5	10/25 ^H	T	O																O
MIA-M10C	4.5x4.5	1.35-1.98 ^{v2}	L1		1.5	10/25 ^H	C	O																O
MAX-M10S	10.1x9.7	1.76-3.6 ^{v1}	L1	NLS	1.5	10/25 ^H	T																	O
MAX-M10M	10.1x9.7	1.76-5.5 ^{v2}	L1		1.5	10/25 ^H	C																	O
u-bloxF10																								
MIA-F10Q [^]	4.5x4.5	1.76-3.6 ^{v1}	L1,L5	SLS	1.0	10/20	T	O																O
MAX-F10S	10.1x9.7	1.76-3.6 ^{v1}	L1,L5	SLS	1.0	10/20	T																	O
NEO-F10N	12.2x16	2.7-3.6	L1,L5	SLNS	1.0	10/20	T																	O
u-bloxM9																								
NEO-M9N	12.2x16	2.7-3.6	L1	NSL	1.5	25/25	T																	O
GNSS receivers with IMU / Dead Reckoning, accelerometer and gyro built-in																								
NEO-M9V	12.2x16	2.7-3.6	L1	NSL	1.5	5(50 ^P)	T															MO		O
NEO-F10V [^]	12.2x16	2.7-3.6	L1,L5	SL	1.0	(50 ^P)	T		nd	nd		nd	nd									MO		nd
GNSS receivers with antenna																								
SAM-M10Q	15.5x15.5x6.3	2.7-3.6	L1	SL	1.5	10/25 ^H	T																	O
DAN-F10Q [^]	20x20	nd	L1,L5	nd	1.0	10/20	T		nd	nd	nd		nd							nd				O

[^] - production start scheduled after printing date, preliminary data nd - information not available before printing date H - 4/18Hz in standard, power efficient configuration
 P- priority navigation mode O- requires external components MO- Multi GNSS Online v1: VIO: 1.76-1.98V, 2.7-3.6V, v2: VIO: 1.68-1.98V, 2.7-3.6V

Feature	Description
Low Power	Power optimisation (i.e. MIA-M10C 9mW at 1Hz) and power saving modes: Cyclic and On/Off tracking.
CloudLocate GNSS service	The snapshot technology, using a cloud location, brings 90% lower power consumption vs stand-alone GNSS. More details in CloudLocate service section on next pages.
Navigation modes	Predefined user profiles (modes) tune algorithms to specific use case (i.e. Wrist mode to filter out arm motion for wrist worn device).
Super-S (weak signals handling)	Configuration to improve dynamic position accuracy under weak L1 signal (small or hidden antennas).
Precision also with Multipath	Mitigation of GNSS reflections (i.e. in the cities) by L1/L5 receivers, and IMU sensors (Dead Reckoning).
Antenna supervisor	Active antenna control and short detection (external components can be required).
Assisted multi GNSS service	Data provided by the u-blox server to boost acquisition, or to be able to get fix despite weak signals and a harsh environment. Brings better performance and lower power. Available as Online, Offline, Autonomous. More details in Assisting Services section on next pages.
Odometer	Embedded algorithms measure travelled distance using the position, Doppler-based velocity, and selected navigation mode.
Protection level	Real-time position accuracy estimate with 95% confidence in automotive environment.
Galileo return link messages	Search and rescue (SAR) return link messages (RLM) via Galileo satellite signal.
Data batching/logging	Tracking and storing data in memory up to 10 min. at 1 Hz, while host uC can stay in sleep mode saving the power.
Wake-on motion	Feature available in Dead Reckoning modules, to identify motion of the device (to save power of central unit, to detect vandalism, towing away for stealing, parking accident).
Design support	Spectrum analyzer built in modules, jamming flags, efficient tool (u-center), high level of support to optimise the final product (including design and log review).

CloudLocate

GNSS on-time just 3 seconds



10% power of standalone GNSS



u-blox service to providing position in 3s with 10% of energy. Use 10x smaller battery, saving space, weight and cost. Or extend 10x your device lifetime!

- switch GNSS On i.e. just for 3s
 - collect data and switch GNSS Off
 - deliver measurements to the service
- That's it! Your server (or device) will get the position from the CloudLocate service.

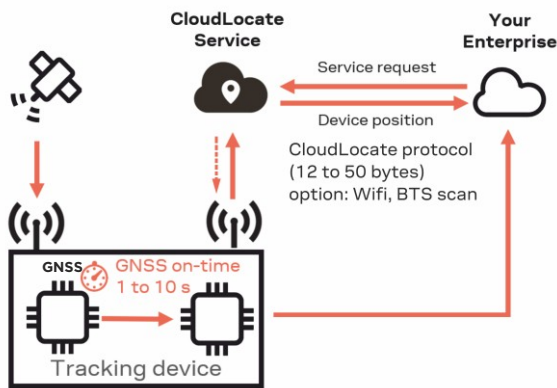

GNSS receiver, using CloudLocate, does not spend time and energy to download ephemeris, and to calculate fix. Runs 1-10 seconds (configurable), sends 12-50 bytes of data and let's u-blox server to make calculations. Position will be delivered directly to your server with no energy used by device, or back to the device, both are possible. Measurements can be live, or collected for up to one month.

CloudLocate prevents also "no position" scenarios i.e. indoors. WiFi and Cellular network measurements delivered and used by service **bring position even in case of no/weak GNSS signal.**

CloudLocate provides 90% of energy savings over standard GNSS receiver, and appx. 10m accuracy. Fits the best if location is required not more than few times per day. For more often updates we recommend our Power Save Modes. Contact our sales team to start your free CloudLocate trial now.

u-bloxM10 complements u-bloxF10, the market proven GNSS platform. Get more than usual performance in smaller than usual, simple in use modules.

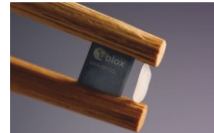

MIA
4.5x4.5x1 mm
Extremely small size

Although **u-bloxM10** is brand new, superb performance already made it the first professionals' choice of robust, standard precision GNSS.

Efficient power optimisation and native CloudLocate support shrink the size of batteries and cost of the system.

u-bloxM10 algorithms, high-grade SAW/LNA and features like Super-S, make **u-bloxM10** the perfect solution for small, portable applications working with weak GNSS signal, or hidden/small antennas.

SAW and Notch filters eliminate noise, including the one coming from GSM or other RF transmitters.

Elaborated **u-blox** features, real Assisted GNSS, filtering of arm motion and many others, fulfil a picture of an outstanding product. Designer does not need deep RF skills, critical components like LNA, SAW, TCXO, antenna can be integrated and matched by **u-blox**.

u-bloxM10, dual band L1,L5 platform, is focused on higher accuracy for urban/indoor scenario with tall buildings nearby. L5 signals help to reduce influence of reflections, two radio sections provide reliable position also in the cities.

We provide the most suitable solution for the particular use case:

- u-bloxM10: for ultra-low-power, high-performance GNSS**
- u-bloxF10: for meter-level accuracy in urban environments**

Both platforms are available in the same form factors, customers have free choice of technology:

- MIA-M10/F10:** miniature, light-weight (0.04g) modules
 - MAX-M10/F10:** well known MAX form factor created in 2011
 - SAM/DAN:** modules with built-in, well tuned antenna
- Advanced Anti-Spoofing, Anti-Jamming and security umbrella built-in by **u-blox** protect device against attacks and manipulations.

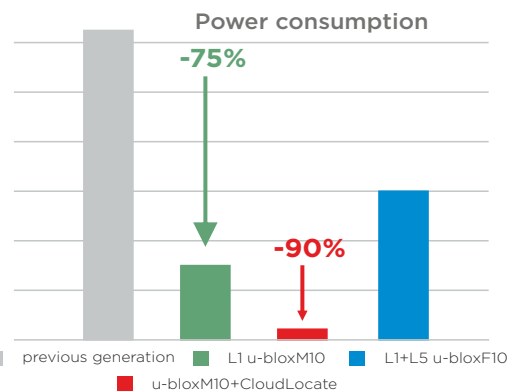

PRECISE GNSS TIMING & FREQUENCY

Timing modules provide nanoseconds timing accuracy to the most demanding infrastructure like 5G, financial or smart power grids, including CVTT (Common View Time Transfer) "all in view" mechanism. Critical applications require high robustness and security, built-in by **u-blox** in security package.

LEA-M8F is a fully self-contained phase and frequency reference, includes low-noise 30.72 MHz VCTCXO, provides 5ppb accuracy, and typical 25ppb autonomous hold-over, used i.e. in Small Cells or to discipline master reference oscillators.

Model	GNSS bands	L-LNA, S-SAW	timing accuracy absolute mode*	timing accuracy differential mode*	frequency synch. accuracy	for 5G networks	CVTT	OSNMA	Security: RAIM, secure FW update, secure boot, configuration lock	RAW data	UART	USB, SPI, I2C
Precise timing modules												
NEO-F10T	L1 L5	S	10ns			●	●	●	●	●	●	
LEA/ZED-F9T	L1 L2, L2 L5	SL/S	5ns	2.5ns		●	●	●	●	●	●	●
LEA-M8F	L1	SLS	20ns		5ppb				Z		●	●

● - next FW release * - 1-sigma Z - selected features supported



HIGH PRECISION POSITIONING

u-blox F9 high precision GNSS platform makes centimetre accuracy available at affordable price.

Complemented by small size of modules and low energy consumption, the market proven technology enables new, high precision applications.

ZED-F9P and NEO-F9P are true mass market receivers. Combining multi-band GNSS signals (L1/L2/L5/E5) and RTK corrections allow for **centimetre accuracy position fix in seconds**.

L5 band and the integrated IMU (in some modules) provide high precision even in challenging environments, such as cities.

All bands product, ZED-X20P, is ideal solution for the sophisticated applications focused on the highest performance.

With its high update rate, the ZED-F9P is suitable for highly dynamic applications such as UAVs, but extremely popular also in **agriculture**. Featuring on-chip integration of advanced RTK algorithms, it requires no additional hardware or third-party RTK libraries. **Using OSR or SSR provides flexibility to the platform.** u-blox F9 may work with both of the standard correction services: the OSR (includes network RTK) but also the single Baseline RTK and the SSR.

UAV

Precise trajectories, fast convergence, accurate geo-tagging

Precision Agriculture

Precise guidance, fast convergence for seeding and herbicides

Automotive

Navigation for AD/ADAS
Level 2 driving automation

Heavy Machinery

Machine control, construction and mining environments

Service Robots

Robotic lawnmower
Unmanned service delivery

Specialty Vehicles

Shared micro mobility that meets locality regulations

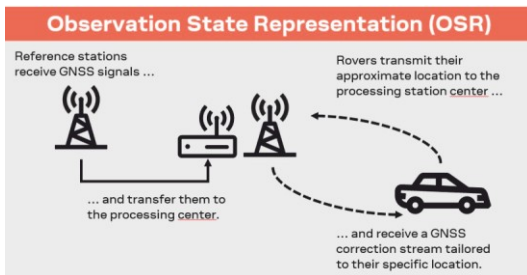

Basic idea

- ! Rover sends position to server every 5 s
- ! Ionosphere/troposphere modelled using nearby reference stations observations
- ! Ionosphere/troposphere caused errors removed from nearest base corrections
- ! Correction GNSS observations sent to rover
- ! One stream per rover
- ! Rover observations removes common errors
- ! Centimetre-level performance enabled

Benefits

- ! Centimetre-level accuracy
- ! Downsides
- ! Only local coverage
- ! High bandwidth needed
- ! Correction data tailored only to a single location
- ! Two-way communication necessary

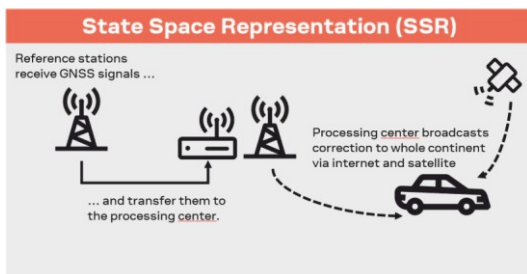

Basic idea

- ! Network models errors over a continent
- ! SSR broadcast stream received by many rovers
- ! Rover able to create localized iono/tropo model
- ! Errors removed from rover observations
- ! cm-level performance achieved

Benefits

- ! Centimetre-level accuracy
- ! Continental coverage
- ! Low bandwidth needed
- ! Correction data valid over entire serviced area
- ! One-way communication

Downsides

The u-blox F9 platform may work also as a stand alone GNSS module. The multi-band, multi-constellation GNSS receiver enables sub-metre level performance without the use of any premium correction services.

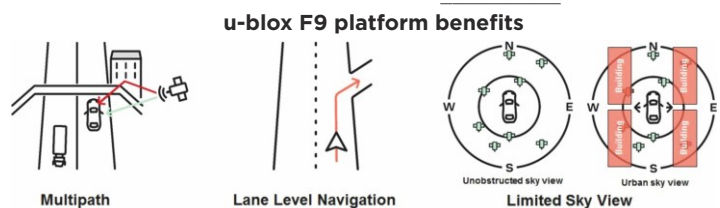

High Precision GNSS modules

Model	Size [mm]	Vcc range [V]	GNSS bands	IMU sensors built-in Additional: L-LNA, S-SAW, N-notch	RTK accuracy	RTK navigation update Multiconst./GPS only [Hz]	Moving base mode	Heading support, accuracy [deg]	Base station mode (corrections source)	Protection level	Data logging	RAW data	Spoofing detection	OSNMA	Jamming detection	Device integrity	UART	DDC (I2C)	USB, SPI	Assisted GNSS Online	PointPerfect	Antenna supervisor	Receiver message authentication
Dual band HPG																							
ZED-F9P-0x	17.0x22.0	2.7-3.6	L1,L2	S	1cm	5/20	●	0.4	●	●	●	●	●	●	●	●	2	●	●	●	●	○	●
ZED-F9P-1x	17.0x22.0	2.7-3.6	L1,L5	S	1cm	7/24			●	●	●	●	●	●	●	●	2	●	●	●	●	○	●
ZED-F9H	17.0x22.0	2.7-3.6	L1,L2	S			●	0.4		●	●	●	●	●	●	●	2	●	●	●	●	○	●
NEO-F9P	12.2x16.0	2.7-3.6	L1,L5	SLS	1cm	7/25			●	●	●	●	●	●	●	●	2	●	●	●	●	○	●
All bands HPG, L-band corrections receiver included																							
xxx-X20P^	17.0x22.0	2.7-3.6	L1,L2,L5, L6,L-band		1cm	25			●	●	nd	●	●	●	●	●	2	●	●	●	●	○	●
HPG receivers with IMU / Dead Reckoning, accelerometer and gyro built-in																							
ZED-F9R	17.0x22.0	2.7-3.6	L1,L2	● S	1cm	4(30°)			●	●	●	●	nd	●	●	●	2	●	●	●	●	○	●
Correction data receiver																							
NEO-D9S	12.2x16.0	2.7-3.6	L - band	S													2	●	●			○	

^ - production start scheduled after printing date, preliminary data ○ - requires external components P - Priority navigation mode ● - next FW release nd - information not available before printing date

POINTPERFECT



PointPerfect is a high performance GNSS augmentation service. Delivering cm-level accuracy positioning within seconds combined with flexible service plans and an easy-to-use delivery cloud platform. Providing the best of the other available solutions PointPerfect brings reliable high accuracy position into a range of mass market applications.

	RTK networks	PointPerfect	PPP services
Technology	OSR (RTK)	PPP-RTK SSR	PPP Some with regional PPP/RTK
Performance	cm level in 10-20 sec.	cm level in 10-30 sec.	<10 cm in 3-30 sec.
Data format	RTCM3.x Open data format	SPARTN Open data format	Proprietary
Required bandwidth	-4.5 kbps	~ 2.5 kbps w/ reduced bandwidth options	-2.5 - 5 kbps
Coverage	Regional / National	Continental Seamless performance	Global Some with areas with localized PPP/RTK; Not seamless
Data stream	Bi-directional	Unidirectional	Unidirectional
Communication	IP-based only	IP-based Satellite L-Band	IP-based Satellite L-Band

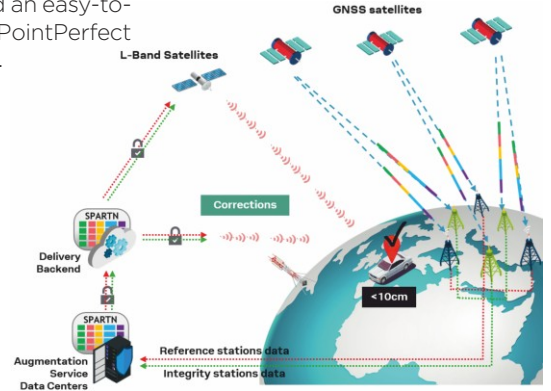

L-BAND RECEIVER



NEO-D9S is a satellite data receiver for L-band correction broadcast, which can be configured for use with a variety of correction services. It decodes the satellite transmission and outputs a correction stream, enabling a high precision GNSS receiver to reach accuracies down to centimetre level.

Depending on the capabilities of the receiver used, it can consume the data output by NEO-D9S as is, or external preprocessing on the host might be needed. By providing an independent correction data stream delivered via satellite L-band, NEO-D9S ensures high availability of the position output and decreases dependency on cellular connectivity for correction service delivered via IP.

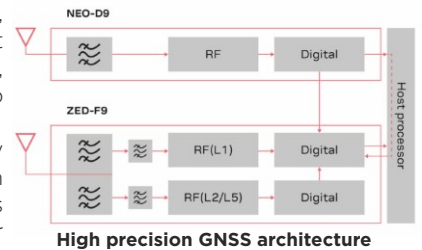

MULTIBAND ANTENNA

A technology which was reserved for military and niche applications is now presented to the mass market - a consumer market - where many times the antenna was not even a part of the design process, and its selection was the last part of the production. Choosing an antenna for the multiband receivers is even more important than with standard single band modules, because providing superb signal levels is crucial for the centimetre level positioning. It is a premium accuracy, and needs additional efforts to guarantee the performance.

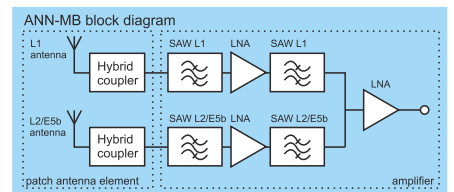

The **u-blox ANN-MB (L1, L2), ANN-MB1 (L1, L5) and ANN-MB2 (L1/L2/L5/E6/B3/L) multi-band active GNSS antennas** are designed to reduce time to market for the next generation of high precision GNSS applications, which require highly accurate location. The **compact design, excellent price-performance ratio** and versatile mounting & connector choices provide customers with fast, easy and reliable multi-band antenna solutions. The ANN-MB antennas are a perfect match to the latest u-blox F9/X20 platforms including the ZED/NEO-F9 and ZED-X20 modules, providing customers with the valuable antenna solution they need to minimize design-in efforts.

All-band, high performance, robust antenna. Well tuned for all bands.

Mechanical data ANN-MB2

Weight	260 g (typ. including cable)
Size	108.5 x 92.9 x 24.7 mm
Cable	5m RG174, SMA
Mounting	Magnetic base, screw mount option
Waterproof	IP 67
Operating temperature	-40 ° C to +85 ° C



ANN-MB2 (L1/L-band L2/E5b/B2I band L5/E5a/B2a/E6/B3/NavIC band)

	L1,L-band (corrections)	L5/L6/E6/L2/B3
Frequency	1535-1602 Mhz	1166-1285 Mhz
Peak gain	Typ. L:5.4 L1: 5.0 dBic	L5: 4.5 L2: 5.0 E6: 4.2 dBic
LNA Gain	Typ. 31 dB	Typ. 31.5 dB
Efficiency	Typ. L: 64% L1: 56%	L5: 55% L2: 60% L6: 50%

Mechanical data ANN-MB/MB1

Weight	173 g (typ. including cable)
Size	60.0 x 82.0 x 22.5 mm
Cable	5 m RG174, SMA, SMB, MCX



ANN-MB (L1, L2/E5b/B2I), ANN-MB1 (L1, L5/E5a/B2a/NavIC)

	ANN-MB (L1, L2/E5b/B2I)		ANN-MB1 (L1, L5/E5a/B2a/NavIC)	
	L1	L2/E5b/B2I	L1	L5/E5a/B2a
Peak gain	Typ. 3.5 dBic	Typ. 0.0-2.0 dBic	Typ. 3.5 dBic	Typ. 1.3 dBic
LNA Gain	Typ. 28 dB	Typ. 28 dB	Typ. 28 dB	Typ. 33 dB

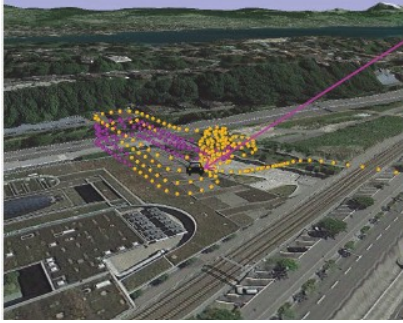

DEAD RECKONING: GNSS + IMU NAVIGATION WITHOUT THE SKY VIEW, MITIGATION OF REFLECTIONS

Increasingly dense urban environments, park houses and multilevel interchanges pose a significant problem to navigation systems. Signal reflected from buildings makes position not accurate. Vehicles are often used in areas where GNSS signal is blocked (tunnel, garage etc).

The latest **NEO-M9V/F10V** and **ZED-F9R** Dead Reckoning (IMU) receivers are result of know-how and experience collected by u-blox over the years of the proprietary Dead Reckoning platform optimisations, providing:

- | excellent navigation performance of u-blox algorithms
- | mitigation of reflections i.e. in city centres
- | navigation in garage, tunnel etc.
- | Anti-Jamming and Anti-Spoofing
- | Wake-on motion
- | RAW sensors data
- | centimetre accuracy (ZED-F9R)

Modern applications require comfort for end user, reliable position and high accuracy also in urban environment with reflections. The solution is Dead Reckoning, GNSS navigation combined with market proven, u-blox sensor based algorithms (IMU). NEO-M9V and ZED-F9R is simple in implementation and efficient solution. NEO-F10V makes use of L5 band for even better mitigation of reflections.

NEO-M9V is based on efficient single band u-bloxM9 platform, while **NEO-F10V** is L1, L5 dual band receiver.

Both, with built-in sensors (gyro, accelerometer), provide accurate 3D position even in case of reflections, or lack of GNSS signal. ADR (with wheel tick signal) and UDR (no wheel tick) are supported.

Dual output is available (GNSS+IMU and GNSS only). Priority navigation mode updates position up to 50 times per second.

Typical applications are the ones working in city centres, expecting reliable position and navigation also in tunnels, garage, and comfort on multilayer roads, like: road tolling, public transportation, fleet management, micromobility (i.e. comfort of end user to find e-scooter fast), insurance boxes and lawn movers.



ZED-F9R is a dual band receiver with RTK High Precision algorithms. Combined with PointPerfect service provides centimetre level accuracy important i.e. for: micromobility in cities with restrictions (like keeping the bike line and speed limits, parking only in marked zones), slow moving robots and lawn movers, agriculture and heavy machines.

RAW sensor data

| information from sensors can be read (up to 100Hz) and used for example to register behaviour of vehicle during an accident

Wake-on motion

- | detect accident when vehicle is parked
- | detect towing away or stealing
- | detect vandalism with e-scooters



ZED-F9R, **NEO-F10V** and **NEO-M9V**, with built-in sensors, bring another level of navigation. Simple integration makes time to market short. u-blox provides complex solution: GNSS receivers, cellular modules (LEXI, SARA, LARA, LENA) with dedicated interface to simplify cooperation with GNSS receiver, and location services (i.e. PointPerfect, AssitNow).

Reliable navigation

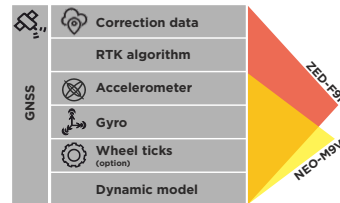

	ZED-F9R	NEO-F10V [^]	NEO-M9V	NEO-M9N
GNSS bands	L1, L2	L1, L5	L1	L1
DR, IMU accelerometer, gyro	●	●	●	
GNSS precision	centimeter	meter	meter	meter
Mitigation of reflections	●●	●●●	●	
Navigation without sky view	●	●	●	
Wake-on motion	●	●	●	
Anti-spoofing	●●	●●	●●	●
Anti-jamming		●●	●●	●
Max. position update freq.	30Hz	50Hz	50Hz	25Hz
Accelerometer, gyro RAW sensor data (100Hz)	●	●	●	
Examples of applications				
Urban (city centre)	●●	●●●	●●	●
Tunnel, garage, multilevel roads	●	●	●	
Fleet management, bus, truck	●●●	●●●	●●	●
Road tolling, vehicle sharing	●●	●●●	●●	●
e-scooters, e-bikes city restrictions	●●	●●	●	
Heavy vehicles, agriculture	●●			●
Lawn movers, railway	●●			●
Motor sport	●	●	●	●

[^] - production start scheduled after printing date, preliminary data

RAW sensor data

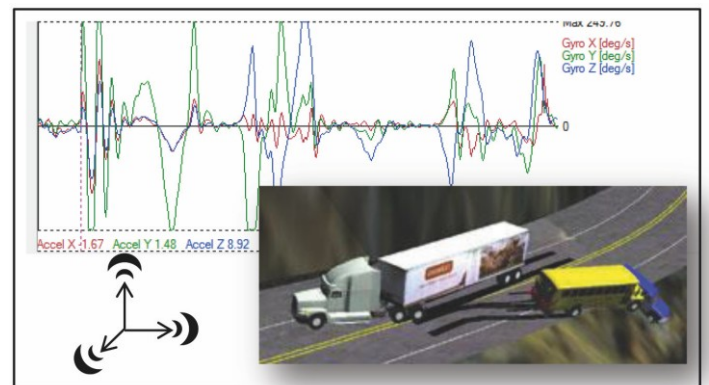

temperature, acceleration, angle reported by NEO-M8L/U during accident

ASSISTNOW SERVICES FOR POSITIONING APPLICATIONS



AssistNow

The modern positioning applications are very demanding. Devices must be low power, small size and able to calculate position under difficult conditions. Small size brings degraded performance of the antenna, as size is very important factor of the GNSS antenna performance. Difficult conditions are effect of small antenna (weak, reflected and corrupted signal), or bad sky visibility due to pocket design, indoor navigation, or urban canyons.

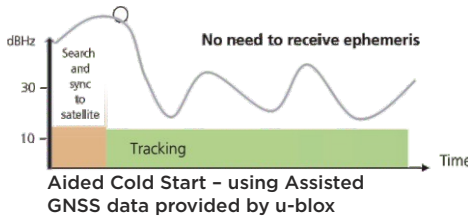
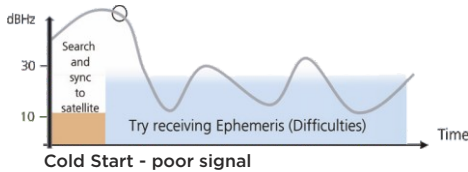
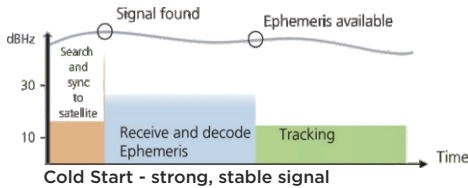
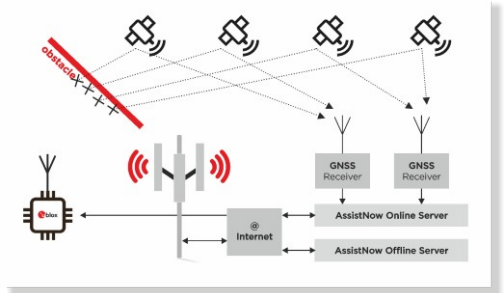

Under **good signal conditions** Acquisition process (cold start) will take appx. 30s, consisting of 2 stages. Searching and synchronization with satellites (SVs) - takes short time. Receiving orbital position data (called Ephemeris) from minimum 4 (3D fix) satellites takes appx. 30s and the receiver starts to navigate (Tracking). Tracking does not need a signal as strong and stable as acquisition.

Under **poor signal conditions** Acquisition takes much more time, or is not possible at all. Collecting Ephemeris from 4 SVs needs uninterrupted good quality signal from each SV for appx. 30s. Under adverse signal conditions it can take minutes, hours or even fail altogether. Lengthy or repeated attempts at data download can also quickly drain power.

u-blox is the leader, and pioneer, in **Assisted GNSS (A-GNSS) technology**, which accelerates calculation of position by delivering satellite data such as Ephemeris, Almanac, accurate time and satellite status to the GNSS receiver via wireless networks or the Internet. This aiding data enables a GNSS receiver to compute a position within seconds, even under poor signal conditions. Assisted GPS, introduced by u-blox in previous generations of the receivers, is already a market proven technology. The latest implementation supports 4 GNSS, including Assisted Glonass, Galileo and BeiDou, improving the performance - it is called AssistNow ,Multi GNSS Assistance (MGA), or A-GNSS.

The system is very simple in configuration and makes applications using GNSS receivers really shining among the competitive units on the market.

AssistNow Online - is the most helpful service to get fix in difficult conditions. The receiver downloads data (real ephemeris) from u-blox' server every time the position is necessary (validity of data is 2-4 hours). Used i.e. in personal trackers (emergency button), theft protection etc.

AssistNow Offline - the receiver downloads the Offline data when Internet connection is available and stores in local memory. Data are valid for up to 35 days. Device uses the data whenever the signal conditions are poor - which improves navigation performance and achieve fast TTFF. AssistNow Offline is useful in all kinds of applications, also to decrease the power consumption (AssistNow makes acquisition shorter - the most power demanding process).

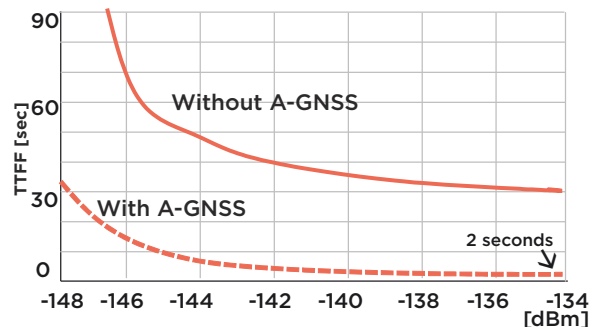

AssistNow Autonomous does not need any data exchange with external server. Orbit prediction data is calculated by the GNSS module itself and is valid for up to 6 days. Activation of this feature is highly recommended.

Although using AssistNow is simple, u-blox cellular modules (LEXI, SARA, LARA, LENA) offer a built-in client handling AssistNow features and using own resources (flash memory).

	ASSISTNOW ONLINE	ASSISTNOW OFFLINE	ASSISTNOW AUTONOMOUS
Data download frequency	At every start-up	Daily or less often	Never
Data retrieval at start-up	Data downloaded from server	Pre-downloaded data from local memory	Retrieved from local memory
Aiding data type	Ephemeris, almanac, time, health	Differential almanac correction data	Automatically generated
Data validity period	2-4 hours	35 days	Up to 6 days
Size of downloaded data	1-4 kB per constellation	10kB (1 day) to 125kB (35 days)	None
Acquisition (TTFF) performance	Typ. 3s	5-20s	13-18s (after 3 days)

DOUBLE CHIP MODULES

A way to integrate cellular technology and GNSS **without compromise**

Combination of cellular and positioning, in the modern, often small IoT device, is not a trivial task. Cellular transmitter uses up to 2W RF power, while GNSS receiver works with signals 100,000 times weaker than GSM. GNSS requires high sensitivity, which also means sensitivity to noise and interference from other components and radio paths. Integration of these demanding wireless technologies can be done in few ways.

Separate modules

Professional applications requiring stable and reliable location usually use independent Cellular and GNSS modules, with own RF paths. It reduces coexistence issues, and brings flexibility, like replacing the module by the other one, with different technology or features to fit the use case.

u-blox supports such concept. LEXI or SARA, LARA, LENA modules, with different technologies, are offered in compatible form factors. GNSS platforms are also available in the same housings (i.e. MAX, NEO, MIA, ZED). Building one platform to serve many use cases is simple. For closer integration, u-blox modules are equipped with dedicated DDC/I2C interface, and software client to connect GNSS receiver directly. (more details on page 18)

Devices called "combo"

The other solution comes from the consumer market, where the location is often needed as just add-on not important feature. Price is the priority, even if functionality is sacrificed. To reduce costs an integrated cellular block is used also as GNSS engine, sometimes even dedicated GNSS antenna is removed. One chipset and one radio for both technologies lead to significant limitations. Position fix is not always available, accuracy is significantly lower. Simultaneous GSM data upload and positioning becomes impossible, energy consumption is higher, the GNSS sensitivity is greatly decreased.

Such compromises, as not acceptable by many professionals, are not supported by u-blox hardware solution. However, for low cost applications not expecting reliable positioning, u-blox offers SpotNow, similar to "combo" software feature.

Double chip

u-blox Double chip approach is to provide high integration of cellular and positioning without performance compromises.

Double chip is one module, but with two independent chipsets and RF paths - one for the cellular, working with high power, the second one as a GNSS receiver, working with very low signals. It is a golden solution wherever reliable GNSS localisation is required, with low power, cost optimisation and working in parallel cellular communication.

The size and cost of Double chip is similar to "combo". Quality of RF parameters, both GNSS and cellular, are like for separate modules. u-blox does offer Double chip modules in SARA and LENA form factors, same as standard cellular modules. It's flexible solution to upgrade the platform with GNSS.

Double chip - parallel work

Double chip modules cellular communication is independent from positioning. In case of "Combo" the communication with the cellular (network attachment, sending data) blocks the RF interface, and the attachment procedure may take a long time. Likewise, the GNSS receiver with weak satellite signal needs a long time to fix the position, blocking the cellular communication.

Double chip - energy consumption

The parallel cellular and GNSS operation in Double chip modules optimises the energy consumption.

The problem of "combo", with no parallel operation demonstrates figure 2. If the GNSS receiver requires more time and therefore is blocking the RF interface, the LTE modem is not maintaining the signalling (paging) with a network, which will result in disconnecting. New registration is a significant energy cost.

Double chip - GNSS path

GNSS signal quality has a direct impact on the time needed to fix the position, Double chip modules are equipped with an additional LNA amplifier and a SAW filter to work with less efficient, passive antennas, and make the time-to-fix shorter, which lowers energy consumption. Modules support also complementary u-blox location services - AssistNow, CellLocate and CloudLocate - making the final solution complete.

Double chip, the new, u-blox approach brings awaited optimisation of the end devices that have to combine cellular and GNSS technologies, without incurring severe compromises in terms of quality and functionality.

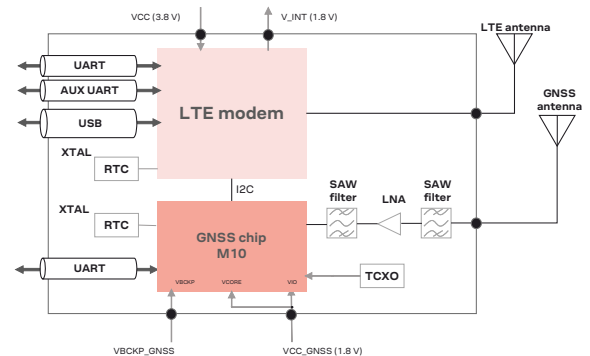

Fig.1 LENA-R8001M10 Double chip module

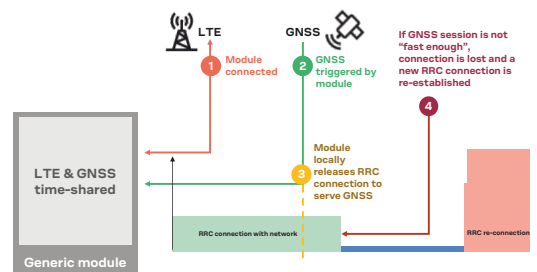

Fig. 2 „combo“ communication issues

Double chip modules	Cellular technology	GNSS technology
SARA-R520M10S	LTE-M, NB-IoT	u-bloxM10
SARA-R422M10S	LTE-M, NB-IoT, 2G	u-bloxM10
SARA-R10001M10D^	CAT.1-bis	u-bloxM10
LENA-R8001M10	CAT.1-bis, 2G	u-bloxM10
SARA-S520BM10^	LTE-M, SAT	u-bloxM10
SARA-S52xNM10	LTE-M, NB-IoT, SAT	u-bloxM10

^ - production start scheduled after printing date

GNSS ANTENNA SELECTION GUIDE

	Embedded				External		
	Passive patch (RHCP)	Active patch (RHCP)	Passive chip (linear polarization)	Passive Helical (tuned)	Active patch	Passive Helical	Active Helical
High gain	○○○	○○○○	●	○○○	○○○○○	○○○	○○○○○
Small size	○○○○	○○○○	○○○○○	○○○○	○○	○○	○○
Power efficiency	●●●●●	○○○	●●●●●	●●●●●	○○○	●●●●●	○○○
Ground plane independence	○○	○○○○	●	●●●●●	○○○○	●●●●●	●●●●●
De-tuning resistance	●	○○○	●	●●●●●	○○○○	●●●●●	●●●●●
Cost	●●●●●	○○○○	●●●●●	○○○	○○○	○○	●

Choosing an antenna, and properly implementing it, is the second most important part of GNSS system design, right behind the module selection.

An antenna choice is a series of trade-offs that an engineer must take into account. Depending on the desired outcome this part of the system must be either power efficient, have high gain or have small size. These three are the main technological arguments, additional ones would be: polarization (linear polarization antennas tend to be more affected by reflected signals than RHCP), de-tuning resistance and ground plane dependence. A sum of six points that are important for antenna operation.

Other arguments that must be considered are based on End-device requirements, and they may include: ease of installation, ease of servicing, robustness, visual design traits (embedded or external antenna) and one of the most significant - cost.

Passive or Active

Because of the weak GNSS signals using passive antennas that are additionally mounted via a long cable can be impossible. That is where active antennas are mostly used. An active antenna is a passive patch with an LNA, and the gain is mostly described as the LNA* gain. Such antennas need to be supplied from a power source, which makes the system less power efficient (an active antenna can consume 10-20mA), but for some applications it is necessary. External antennas are also very popular because there is very little design needed - just plug the antenna to the RF connector.

*Low-noise amplifier (LNA) is an electronic amplifier used to amplify possibly very weak signals (captured by an antenna). The LNA boosts the antenna signal to compensate for the feedline losses going from the (outdoor) antenna to the (indoor) receiver. It amplifies both noise and signal, so it does not affect the SNR.

Patch, chip or helical

Deciding which antenna to use is directly connected to the end-device application. Some rules of thumb for the designer exist however:

- ! A power hungry antenna in a battery driven system is not desired.
- ! A ceramic patch or chip in a pocket application will detune due to human body proximity.
- ! A fixed system will work better with a big 25x25mm patch, with optimal ground plane, than with a helical or chip antenna
- ! A small patch will never have optimal performance, it is a trade - acceptable performance with small size. The performance depends on groundplane size.
- ! A chip will be worse than a patch in almost all cases - exception: it will work better if the device is flipped upside down.
- ! A helical antenna has lower directional gain, but will work better inside a pocket and in a device position changing application.
- ! An external active antenna mounted on a i.e. car (metal) roof will have the best possible gain and may be used as a reference.

Gain

Gain describes how well the antenna converts radio waves arriving from a specified direction into electrical power or how well it converts input power into radio waves headed in a specified direction. When no direction is specified, gain is understood to refer to the peak value of the gain. A plot of the gain as a function of direction is called the radiation pattern.

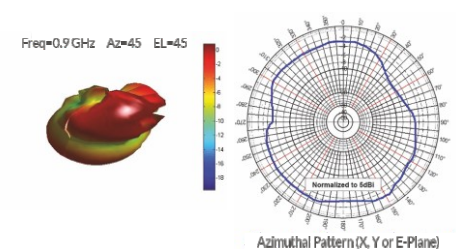

Ground plane

A ground plane is the most important design issue to consider while developing a GNSS receiver system. A dependable antenna can lose all attributes (gain, polarization, center frequency) if a ground plane is small or non-existent. In almost all cases the parameters stated in the datasheets are based on measurements done with the antenna placed on an optimal ground plane (i.e. 50x50mm), which is a very important point to remember when testing the antenna. The distance to ground plane edge has a similar effect to the size of the ground plane.

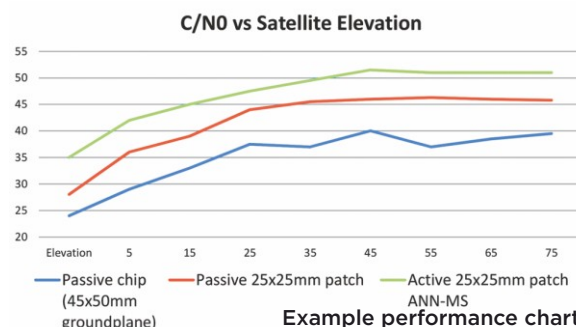
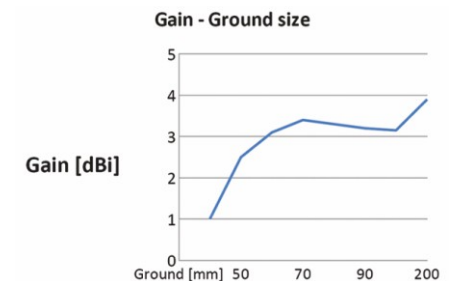

Example performance chart

POSITIONING TOOLS

SOFTWARE TOOLS

For easy evaluation, configuration, testing and performance analysis u-blox provides a series of software tools, called u-center (for GNSS), m-center (for Cellular) and s-center (for Short Range products). The "centers" are PC-compatible, and provide an intuitive, easy to understand and use graphical interface. They may also be used for firmware upgrades.

u-center - a highly intuitive GNSS evaluation software that is easy to use, personalized, and compatible with leading u-blox technologies. u-center supports u-blox F9/M9/M8 and older products.

u-center optimised user experience includes personalized workspaces and adaptive window elements. Its log player provides easy message-based and time-based navigation with adjustable playback speed and u-center log file import.

u-center 2 - the next generation of the software, supports the u-blox M10 /F10/X20 and newer products. It's quick product configuration allows users to define or apply GNSS receiver setup for specific use cases. Saving, restoring, or sharing configurations between different products and users is easy. The software supports product evaluation with a choice of views to observe static and dynamic behaviour of the connected u-blox GNSS receiver. The software enables easy setup and evaluation of u-blox GNSS services such as AssistNow.

Regular updates of u-center 2 are provided to ensure the software always has the latest functionalities and pre-defined configurations, and to add support for the most recent firmware of u-blox GNSS receivers. The user is informed at startup and can install the update with a single click.

ubxlib - portable open-source libraries simplifies development, more details available in UBXLIB section on next pages. Check github repository or contact us for further support.

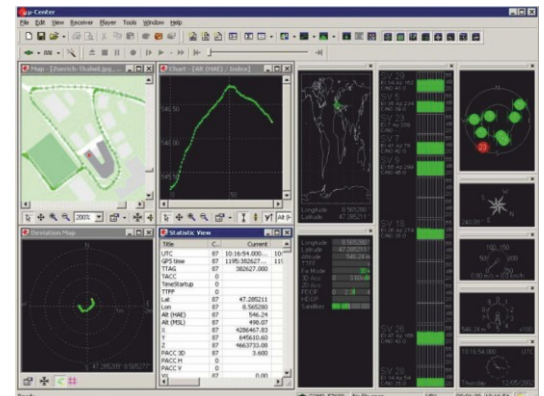

u-center

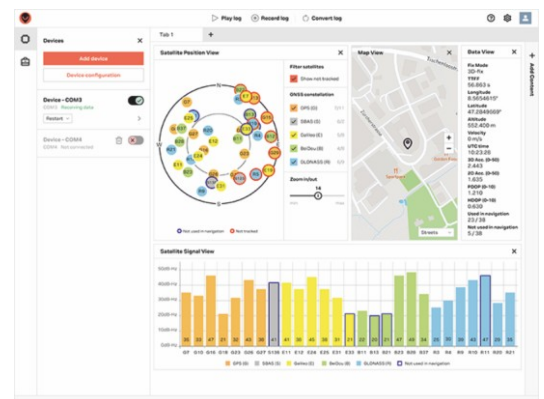

u-center 2

HARDWARE TOOLS

EVK-xxx evaluation kits provide a simple, flexible and ready to use environment for evaluating of u-blox' modules, as well as for designing and testing of wireless and GNSS applications. EVK is a typical, but proven design, and can be used as reference to compare performance of device under tests or development.

GNSS kits enable simple evaluation of the high performance u-blox positioning technology. The built-in USB interface provides both power supply and high-speed data transfer, and eliminates the need for an external power supply. The evaluation kits are compact, and their user-friendly interface and power supply make them ideally suited for use in laboratories, vehicles and outdoor locations. The kits are to be used with a PC via USB interface. USB drivers are provided with the software package.

XPLR-HPG-1/2 explorer kits provide a complete platform for evaluation of u-blox high precision GNSS solution and PointPerfect correction service. Free choice of communication technology built-in: GNSS corrections can be received over LTE (LTE module included), over IP (WiFi module included) or over L-band satellite GNSS (L-band receiver included). XPLR-HPG-1 is based on Click boards to attach the most suitable set of modules, XPLR-HPG-2 is equipped with fixed ZED-F9R, NEO-D9S, LARA-R6 and NINA-W1 modules.

RCB-F9T timing boards provide fast and simple access to the superb u-blox timing technologies. With industry standard form factor and an SMB antenna connector devices support L1, L2 and L1, L5 bands.



EVK-F9P evaluation kit



XPLR-HPG explorer kits



RCB-F9T timing board

CELLULAR FOR IOT:

LTE CAT.1/1-bis, CAT.4, LTE-M, NB-IOT, SATELLITE IOT, 2G

u-blox offers scalable and secure cellular modules for the devices with demanding size, cost, and quality requirements. LPWA (5G), LTE (4G), 3G and 2G modules are optimised for professional applications such as micromobility, asset tracking, fleet management, road pricing, vehicle recovery, security or metering.



The use of u-blox' cellular modules does not lead to consequences from infringement of patents and copyrights. Modules are qualified for in-vehicle use (AEC-Q104 subset)

The evolution of technology - do not leave your application behind

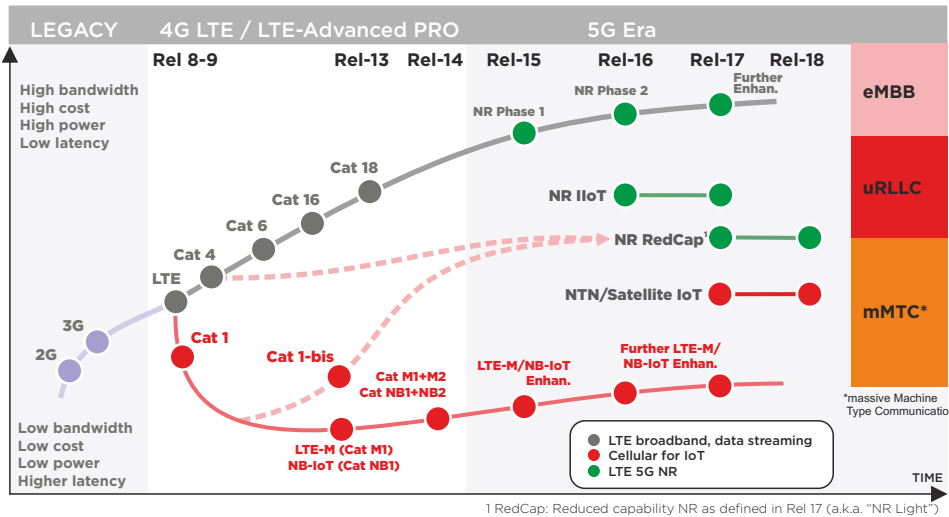

The cellular technology is evolving in two different directions:

- Gigabits speed:** for data streaming, available as 5G eMBB, with high power and cost, required mostly by the consumer market
 - Cellular for IoT:** for customers aware of 2G sunrise. LTE Low Cat. modules, 5G mMTC in the future, provide stable, low/medium speed network with longer availability, keeping the cost and power consumption low.
- u-blox is a leading supplier of cellular modules meeting such industrial IoT requirements.**

- 2G:** matured but still good coverage in some regions, like Africa or Europe, data and voice available, the lowest cost products.
- LTE-M, NB-IoT:** modern, power & cost optimised LTE standard (LPWA). Tailored for IoT, able to work with weak signal. Supported by most, but still not all cellular network providers, roaming not always available. Considered as 5G. Cost optimised solution in LTE family. Data (voice considered by the networks in the future), 2G fallback available.
- LTE Cat.1:** "traditional" LTE with excellent coverage and roamings, Rx diversity (two antennas) for improved link quality. Balanced cost between Cat.4 and LTE-M. Data and voice, 2G/3G fallback available.
- LTE Cat.1-bis:** simplified LTE Cat.1 to reach low cost and power level of LTE-M. One LTE antenna, excellent coverage and roamings. Data and voice, 2G fallback available (mostly not necessary).
- LTE Cat.4+:** optimised for high speed and data link quality, higher power and price than Cat.1. Data and voice, 2G/3G fallback.
- 5G:** currently the eMBB category was introduced, for high speed data streaming. RedCap is still under planning.

IOT-NTN/NR-NTN: Non-Terrestrial Network (NTN) communication defined in 3GPP Rel. 17 based on GEO (Geostationary) or LEO (Low Orbit) satellites. LEO could play important role when constellations will be in place. Currently constellations are GEO, like IDP by Orbcomm, soon evaluating into GEO NTN, and in the future into LEO NTN. u-blox supports customers with SARA-S5 modules, keeping pin compatible SARA module in medium/long-term roadmap with LEO support.

LPWA BY U-BLOX

ABILITY TO MODIFY THE NETWORK SETTINGS FOR LOWER POWER

Power consumption is the most important parameter for NB-IoT technology. The throughput and response time are not critical. Amount of data is small, sent infrequently. Responses from the server can be buffered by the network, which is simplified by publish-subscribe services utilized by CoAP or MQTT.

NB-IoT brings many additional features to tune the application and network for the lowest energy consumption in a given scenario. u-blox modules are well tuned by experienced team of engineers to support these features.

FAEs provide support to u-blox customers for efficient configuration.

Power Saving Mode (PSM) - the module shall remain registered but in deep sleep (3uA) for most of the time. Wake up is possible with data to be sent, or on a schedule by T3412 timer (even once per several days). Dedicated for applications where most traffic will be Mobile Originated.

eDRX (extended Discontinuous Reception) - the module wakes up in scheduled paging occasions, during which reception is possible, with an interval of up to 3 hours between them. Dedicated for Device Terminated applications.

RRC Release Assistance - unique feature for NB-IoT supported by u-blox modules, can influence RRC Release network timer to significantly reduce the power consumption. After data package is sent application requests immediate RRC release from the network, instead of default network behaviour which is 10-20s RRC release time.

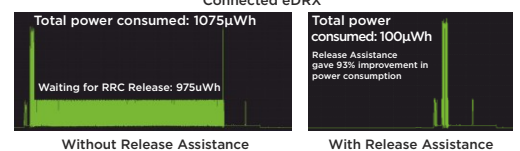
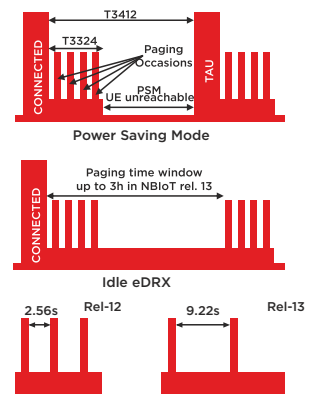

CELLULAR & SATELLITE IOT: LTE CAT.1/1-bis, CAT.4, LTE-M, NB-IOT, SATELLITE IOT, 2G

NB-IOT

SARA-N3

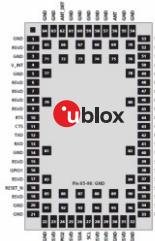

LTE-M
NB-IOT,2G

SARA-R4
SARA-R5

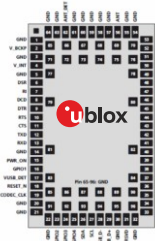

LTE-M, NB-IOT,
SATELLITE

SARA-S5[^]

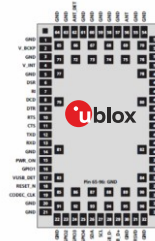

CAT.1-bis

SARA-R10[^]

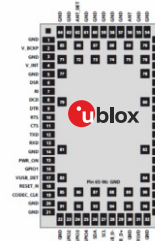

CAT.1-bis, 2G

LENA-R8

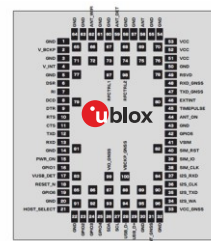

CAT.1, CAT.4, 2G

LARA-R6
LARA-L6

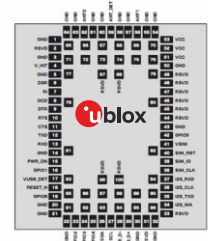

[^] - production scheduled after printing date

Easy migration path u-blox nested concept

Various modules can be alternatively mounted on the same board space:
one PCB for 2G, 4G (LTE Cat.1, Cat.1-bis, Cat.4), LPWA (LTE-M, NB-IoT) and Satellite IoT.
High level of pads compatibility and example of design to minimize migration effort.

2G
SARA-G4

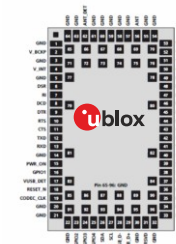

LEXI, SARA, LARA, LENA - selected features

Modules optimised for low power, small size, cost saving and professional applications

Feature	Description
Pin compatibility between technologies	Different technologies (2G, 3G, NB-IoT, LTE-M, Cat.1-bis, Cat.1, Cat.4, SAT) are available in SARA, LARA, LENA pads compatible form factors. One PCB can be ready for any technology.
MNO Profiles	Preconfigured MNO profiles implemented in u-blox modules simplify proper configuration requested by the particular network provider.
Design support to reduce time-to-market	Features built-in by u-blox to support development, i.e. greeting message (detects unexpected resets), low level trace logs (provides log with low level module-network communication for the further analyze), test command (+UTEST) to simplify production testing.
Production testing	
Dynamic LTE antenna tuning	Simplifies efficient antenna design. Control via two GPIOs an external antenna matching IC according to the LTE band used by the module. 4
Security	Built in Secure Boot and u-blox secure ecosystem.
Backup and restore	Allows the modules to autonomously restore the key data stored in the flash memory integrated in the module using the last backup data stored in the memory itself.
Last Gasp	Sending a predefined last notification (via SMS or TCP/UDP) in case of power outage, just before the power goes off. 7
Low power	The market leading low power consumption across technologies. 8
RRC Release Assistance (RAI)	Feature supported by the most low power advanced LTE Cat.NB2 (NB-IoT) modules like SARA-N3. Request to drop RRC connection as soon as the message has been received by the network. Saves even 93% of power (calculated with 200 bytes data packages). See more on page 13 9
Antenna/SIM detection	Provides antenna/SIM presence detection capability. 10
CoAP, MQTT, LWM2M	Support of protocols dedicated to IoT/M2M. 11
BIP/eUICC	Bearer Independent Protocol for remote Over-the-Air SIM provisioning (network provider profile change). 12
eSIM	Embedded SIM with profile of network provider (MNO). 13
SNI	Server Name Identification - extension of SSL/TLS which allows the server to present different certificates for different base URL's pointing at the same IP address 14
RPM	The Radio Policy Manager (RPM) - reduction of the power consumption as the module does not retry an unnecessary service. User friendly for networks - a must demand from some providers.
Jamming detection	Detects and reports potential jamming. 16
CellLocate service	Localization using BTS or WiFi signals, not as accurate as GNSS, but very helpful and supplementary (i.e. in a car park, where a GNSS signal is unavailable). 17
Wi-Fi sniffer / scan	Wi-Fi 2.4GHz receiver detecting Wi-Fi networks, using the LTE antenna, for localization via CellLocate service, or as raw data available for the application. Main positioning service, or backup if i.e. GNSS signal is not available or corrupted. 18
AssistNow client	Embedded AssistNow Online and Offline service clients to provide better GNSS performance and faster Time-to-First-Fix. 19
External GNSS control	GNSS receiver can be connected directly to cellular module, creating tandem. (see more on page 18). 20
LTE Rx Diversity	Improved cellular link quality and reliability on all operating bands, by means of 2 receiving antennas. 21
FOTA / uFOTA	Firmware Over The Air update allows to keep even the deployed devices up to date with the newest functionalities.
AWS modules	The embedded AWS IoT ExpressLink certified software provides tailored AT commands to access AWS cloud straight out-of-the-box, without the need to integrate any additional API on the MCU. Feature significantly accelerates time-to-market. 23
UBXLIB	C libraries to easily and fast build applications supporting Cellular, Positioning and Short Range products. More details in UBXLIB section on next pages. Check github repository or contact us for further support.

CELLULAR & SATELLITE IOT:

LTE CAT.1/1-bis, CAT.4, LTE-M, NB-IOT, SATELLITE IOT, 2G



The latest portfolio of LTE modules

	LTE Category Downlink/Uplink	2G GPRS SATellite	GLOBAL REGIONAL version	LPWA extended coverage, TX Power	Two LTE antennas	Power supply [V]	UART/USB	DDC(I2C) to connect GNSS module	VoLTE/CSFB over digital audio	Integrated u-blox GNSS with high performance RF	External GNSS control	AssistNow GNSS client	CellLocate	WiFi scan	MQTT Anywhere, MQTT Flex	LTE antenna tuning	Antenna/SIM detection	Jamming Detection	Last Gasp	USIM/BIP (SIM Provisioning)	Integrated SIM	openCPU	TCP,UDP,HTTP, HTTPS/FTP,FTPS	TLS(SSL), SNI / DTLS	DNS ¹	PSM Power Saving Mode, Deep Sleep current	eDRX / RAI (RRC Release Assistance)	CoAP/MQTT/MQTT-SN	LWM2M	Zero Touch Provisioning AWS, Azure	
LTE Cat.1/1-bis					21			20		20	19	17	18		4	10	16	7	12	13			14	8	9	11	11				
LEXI-R10801D	CAT1bis		EMEA,APAC, BRAZIL			3.3-4.5	2/1														v				2uA						
LEXI-R10401D	CAT1bis		AMERICAS			3.3-4.5	2/1														v				2uA						
LEXI-R10001D[^]	CAT1bis		GLOBAL			3.3-4.5	2/1														nd				2uA						
SARA-R10001D[^]	CAT1bis		GLOBAL			3.3-4.5	2/1														v	nd			2uA						
SARA-R10001M10D[^]	CAT1bis		GLOBAL			3.3-4.5	2/1			M10											nd				2uA						
LENA-R8001	CAT1bis	2G	GLOBAL			3.2-4.5	1/1																		2uA						
LENA-R8001M10	CAT1bis	2G	GLOBAL			3.2-4.5	2/1			M10															2uA						
LARA-R6001/D^o	CAT1	2G,3G	GLOBAL			3.1-4.5	2/1																		11uA						
LARA-R6401/D^o	CAT1		N.AMERICA			3.1-4.5	2/1																		11uA						
LARA-R6801/D^o	CAT1	2G,3G	EMEA,APAC, S.AMERICA			3.1-4.5	2/1																		11uA						
LARA-L6004/D^o	CAT4	2G,3G	GLOBAL			3.1-4.5	2/1																		11uA						
LARA-L6404/D^o	CAT4		N.AMERICA			3.1-4.5	2/1																		11uA						
LARA-L6804D	CAT4	2G,3G	EMEA,APAC, S.AMERICA			3.1-4.5	2/1																		11uA						
LARA-L6824/D^{o^}	CAT4		JAPAN			3.1-4.5	2/1																		11uA						
LTE-M, NB-IoT																															
SARA-N310 Atex	NB2		GLOBAL	23dBm		2.6-4.2	1+D/-																			3uA					
LEXI-R520	M1,NB2		GLOBAL	23dBm		3.0-4.5	2/D																		0.5uA						
SARA-R520	M1,NB2		GLOBAL ³	23dBm		3.0-4.5	2/D																		0.5uA						
SARA-R520M10S	M1,NB2		GLOBAL ³	23dBm		3.0-4.5	2/D			M10															0.5uA						
SARA-R540S[^]	M,NB2		GLOBAL+	23dBm		3.0-4.5	2/D																		0.5uA						
SARA-R500E	M1		N.AMERICA	23dBm		3.0-4.5	2/D																		62uA						
SARA-R510AWS²³	M1		GLOBAL	23dBm		3.0-4.5	1/D																		0.5uA						
LEXI-R422	M1,NB2	2G	GLOBAL	23dBm		3.0-4.5	2/D																		3uA						
SARA-R422	M1,NB2	2G	GLOBAL	23dBm		3.0-4.5	2/D																		3uA						
SARA-R422S	M1,NB2	2G	GLOBAL	23dBm		3.0-4.5	2/D																		3uA						
SARA-R422M10S	M1,NB2	2G	GLOBAL	23dBm		3.0-4.5	2/D			M10															3uA						
LTE-M, SAT																															
SARA-S520BM10[^]	M1	IDP	GLOBAL+ SAT	23dBm		3.0-4.5	2/D			M10															1uA					nd	
SARA-S528NM10[^]	M1,NB2	NTN GEO	GLOBAL+ SAT	23dBm		3.0-4.5	2/D			M10															1uA		nd			nd	
SARA-Sxxx[^]	M1,NB2	NTN LEO	GLOBAL+ SAT	23dBm		3.0-4.5	2/D			M10															nd		nd			nd	
2G GSM/GPRS																															
SARA-G450		2G	GLOBAL			3.4-4.2	2+D/-	Analog																							SSL

[^] - production start scheduled after printing date, preliminary data O - version D is data only
 ● - in future FW version available after printing date nd - information not yet available
 1 - not every NB-IoT network supports DNS 2 - not for external GNSS v - feature in dedicated version D - for diagnostic
 M10 - u-bloxM10 receiver 3 - versions for Japan, Korea are available 4 - MQTT for AWS only

CAAS - COMPLETE IOT COMMUNICATION SOLUTION



Thingstream provides a comprehensive, end-to-end solution for global IoT connectivity using the industry standard MQTT protocol. The product is offered "as-a-service" which provides predictable cost and on-demand scalability for customers.

MQTT has become a widely used data transfer protocol in the Internet of Things, along with MQTT-SN, which is tailored to the needs of sensor networks. Designed for constrained environments characterized by low power and bandwidth requirements, MQTT transmits messages from one device to one or many others via a broker.

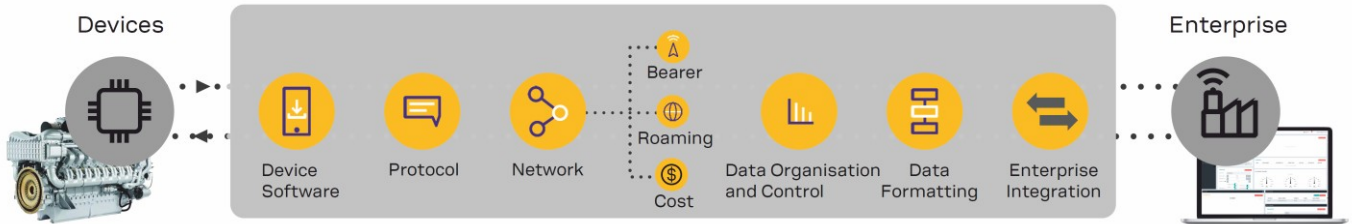

Communication is so much more than connectivity. u-blox solves the problems of complexity, cost and availability

u-blox bearer-agnostic approach to getting data from devices to the enterprise is simplified through the availability of complimentary products. These products are built on top of the foundation of a scalable, high performance MQTT broker and powerful Data Flow Manager, allowing simple processing, transformation, control and integration of messages into the enterprise.

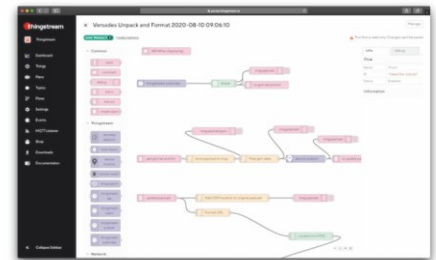

MQTT Anywhere: u-blox SIM based service operating across multiple cellular carriers in 190 countries around the world. Fixed price, low-cost, global connectivity, globally ubiquitous, seamless roaming.

MQTT Flex: any SIM based service to keep the relationship with the preferred network provider. Predictable cost and on-demand scalability.

MQTT Here: solution for LoRaWAN, simplifies LoRaWAN rollout.

MQTT Now: Cloud-based MQTT integration for IP devices.

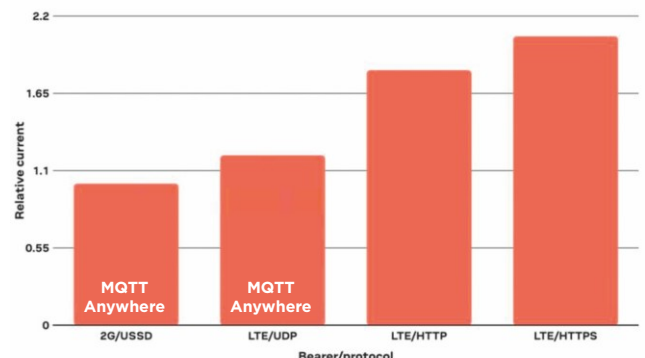
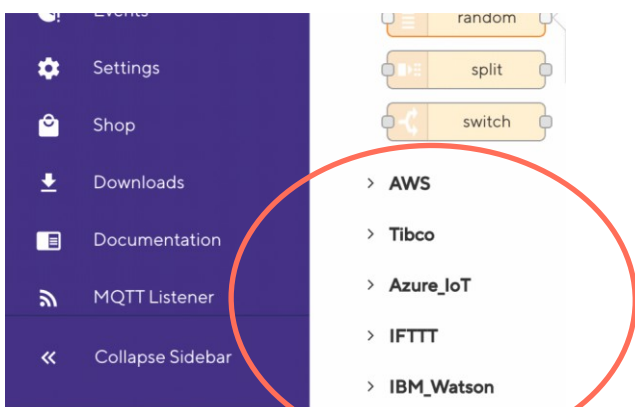
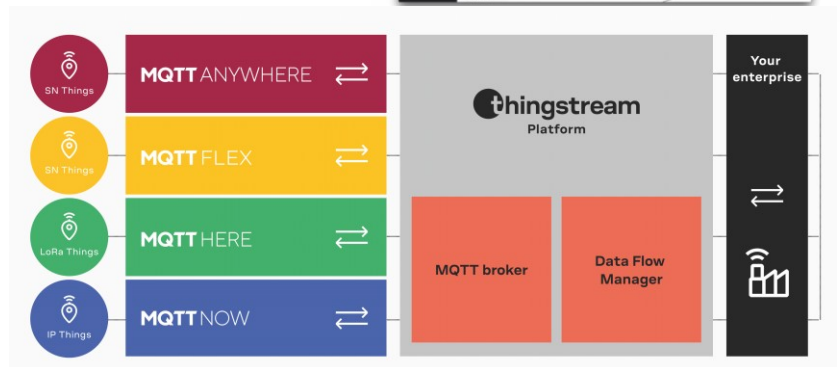

ultra low power solution

Seamless integration into leading cloud platforms



UBXLIB: u-blox host library

#ubxlib

Simplified development with u-blox products and services

ubxlib provides C libraries and examples to build embedded applications easily without the need of reading manuals and understanding dedicated AT commands or UBX messages. High-level APIs handle network sockets over cellular or Wi-Fi connectivity while low-level APIs support dedicated AT commands or the UBX protocol. The location API enables positioning with GNSS modules. The BLE API offers functions for configuration and data exchange over Bluetooth LE. With the MQTT client API a developer can connect and communicate to an MQTT broker.

ubxlib C APIs are concise and uniform across multiple u-blox modules. Once set up, the code needs minimum maintenance, even when using a different or newer product. This add-on to existing microcontroller and RTOS SDKs facilitates the integration of connectivity, localization and security into any embedded application.

Ready-to-use examples for various applications

Ready-to-use examples demonstrate how the APIs are used together with u-blox products and cloud services to build solutions for many real-world problems.

The library includes basic examples for product initialization and firmware updates as well as examples using specific u-blox product features. More complex examples cover integration of sensors or demonstrate solutions that combine a selection of u-blox modules and services.

Benefits of using ubxlib:

- | Rapid application development through concise and easy-to-pick-up C APIs
- | Portable open-source C libraries available on GitHub and PlatformIO
- | Ready-to-use example code for u-blox products and services
- | Wide support for most common processors and operating systems
- | Minimized software migration effort for u-blox product upgrades

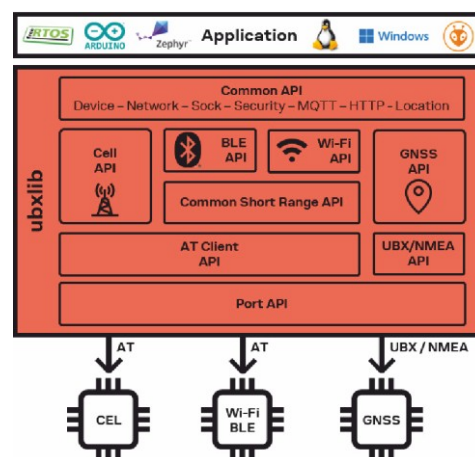

Wide product and development platform support

ubxlib works with u-blox cellular, Bluetooth, Wi-Fi, and GNSS products, and supports u-blox CellLocate, CloudLocate, MQTTNow, and MQTT Anywhere services.

To find out which u-blox products and services, MCUs, open CPUs and RTOSs are directly supported, please visit the ubxlib GitHub page.

However, open library can be used as template for any platform.

CELLULAR TOOLS

SOFTWARE TOOLS

m-center - The m-center cellular evaluation software is a powerful and easy to use tool for evaluating, configuring, and testing u-blox cellular modules. It includes an intuitive, easy to understand and easy to use graphical interface.

m-center is available free-of-charge. m-center provides a convenient means to configure u-blox cellular modules and save the configuration in the module EPROM. It is also possible to view and edit SIM phonebook entries, send text messages, and communicate with the wireless module using AT commands - with the possibility to save them and provide to technical support.

The software also supports scripts for quick evaluation of multiple products and is equipped with predefined commands available at a click.

m-center can be used to restore the factory default settings or to perform traces (diagnostic logs). In addition, when using evaluation kits, m-center allows for simple communication with the onboard GNSS module. It's popular tool also due to the **engine for running AT scripts, and own GitHub repository for scripting.**



m-center

HARDWARE TOOLS

EVK-xxx evaluation kits are a simple, flexible and ready to use environment for evaluating of u-blox' modules, as well as for designing and testing of wireless but also GNSS applications.

The **cellular EVKs** provide a modular design that allows replacing an adapter board (ADP-xx with cellular module) to test selected technology on the same main board. The cellular kits come with a built-in u-blox GNSS receiver module (or are equipped with the Double Chip cellular module, with integrated GNSS), to either test cellular functionality alone or to integrate it together with u-blox GNSS technology. For evaluating AssistNow (A-GNSS) a u-blox A-GNSS client is embedded in the firmware stack.

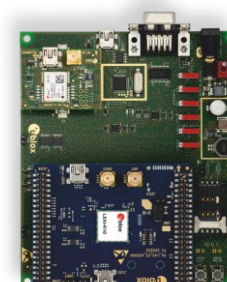

EVK-LEXI-R10 kit

SMART AND EFFICIENT COOPERATION CELLULAR AND POSITIONING

Modern applications often requires two technologies: GNSS positioning and cellular communication.

Expectation is to have cost, size and power optimised solution, but providing reliable positioning service without compromise. Possible options have been described on page 10.

Performance of one chipset „combo” modules is often too much degraded to be accepted for the professional application (more details on page 10).

Double chip solution brings high integration without compromise, but the number of combinations of technologies supported by available double chip modules is limited.

Full flexibility, simple replacing one module, with the other, with different features or technology, is ensured by two modules design, especially considering u-blox strategy to offer same/similar form factor across technologies.

Following common on the market two modules concept u-blox offers optimised integration:

- dedicated interface (DDC/I2C) allows to connect GNSS receiver directly to cellular module
- dedicated features merge two platform into one localization platform
- additional services (CellLocate, AssistNow, CloudLocate) make the package complete

Connecting u-blox' cellular and GNSS modules together simplifies design (one UART is enough), allowing full access to GNSS receiver via the cellular module. It is also possible to use very useful features built-in GSM/LTE modules like:

- GNSS power control with AT commands (GNSS supply enable)
- AssistNow client, handling of A-GNSS data exchange and storage (Flash memory in cellular module)
- time synchronization between modules (GNSS RTC sharing)
- GNSS data ready - optimises power consumption, since it wakes-up application only when there is data ready from the GNSS receiver



Moreover, u-blox cellular modules offer CellLocate service, making such cellular and positioning tandem not only highly integrated and low power, but also an extremely functional solution, offering information

about position even under poor or no GNSS signal, or jamming. Cellular module collects information from visible cells and reports to CellLocate server, where position is calculated. CellLocate server returns the position and confidence level, i.e. 95% level means a 5% probability that the device is farther than the exposed value, from the estimated position. CellLocate has been recently enriched by WiFi scan, making it even more helpful.

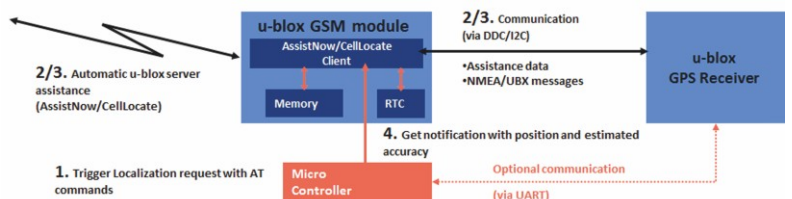
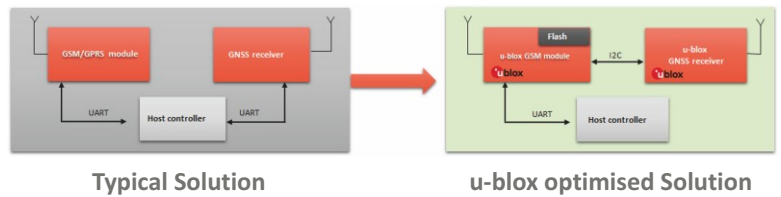

Full cooperation between u-blox' wireless and GNSS modules is possible with very simple hardware design, presented on picture.

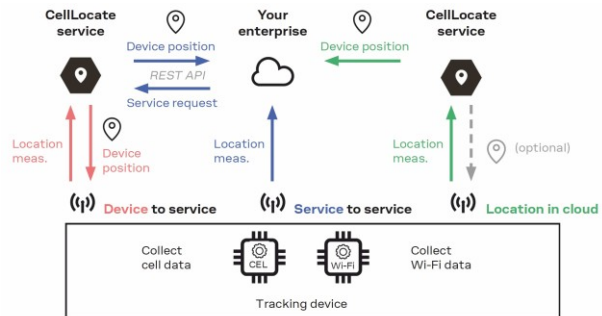
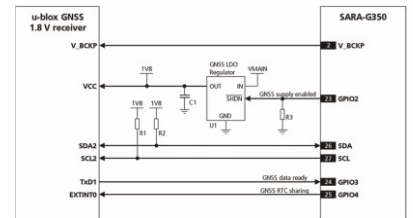

Three different CellLocate implementations



CellLocate fix with provided confidence level

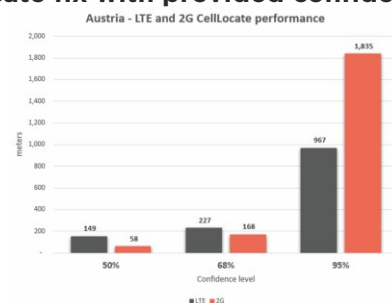

Regional confidence level statistics

SHORT RANGE MODULES

Stand-alone modules are equipped with a powerful processing unit and built-in Wi-Fi/ BT stacks. They work as a Wi-Fi or BT transceiver, with reliable, secure and approved by u-blox firmware (uCX), or customer application (open CPU). Make design time shorter, and certification, due to u-blox approvals, easier.

Host-based modules run the stack and applications on an external host processor. The Host can be an Android, Windows, Linux or RTOS based unit. Integration with an OS requires experience and longer development time, but allows higher flexibility in application design and utilization of specialized software from third party companies. Most of the Host-based modules are dedicated for Automotive and demanding Industrial applications. u-blox' Automotive grade guarantees that the units will perform without a hitch even in demanding conditions.

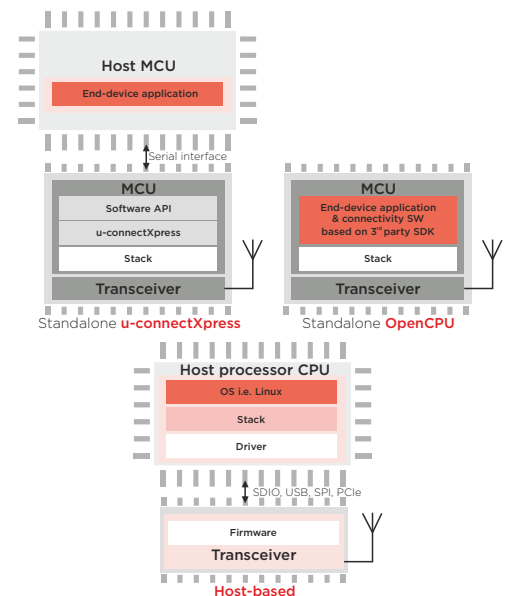

Providing different technology in pin compatible form factor (like NINA, MAYA or NORA series) is one of the driving forces that draws the professional industrial customers to u-blox.

Classic Bluetooth v2.1/v3.0 - robust communication, but needs time to connect, high data rates, older phones are equipped with it. Agreement with Apple must be signed to communicate with iOS devices.

BLE - Bluetooth low energy (v.4.0-5.4) also known as Bluetooth Smart, low payload, fast negotiation and connection, low power, most smartphones are equipped with BLE, works also with iOS. BLE is not compatible with Classic.

Bluetooth dual-mode (BLE +Classic BT) modules are known as Bluetooth Smart Ready.

Thread is an IPv6-based, low-power IEEE 802.15.4 mesh networking technology for Internet of things (IoT) products, uniquely making each node an access point in the network.

Matter is a unified IP-based protocol to securely and robustly connect smart devices with each other, regardless of brand, and across smart home ecosystems. Matter is using Thread, Wi-Fi, and Ethernet for transport and Bluetooth LE for commissioning.

All Matter devices based on Thread are required to feature Bluetooth LE concurrently to enable adding new devices to a network.

BLUETOOTH & UWB INDOOR POSITIONING

Bluetooth direction finding, introduced with BLE 5.1, lets users locate assets indoors with meter-level accuracy, since it makes it possible to determine the direction that radio signals travel between the mobile client and one or several fixed anchor points. Two solution architectures are possible:

one based on the radio signal's angle of arrival (AoA) at the anchor point, the other based on its angle of departure (AoD). Only specific modules can transmit and receive the dedicated data streams, and only raw data is provided.

It is up to the application to use that information and calculate the angles and latencies into a viable position. This is why u-blox has developed the **u-connectEmbed** software, that can run on dedicated u-blox modules. u-connectLocate runs on top of the stack and offers developers an easy-to-use command API for calculating the angle right on the Bluetooth module. The embedded software handles RF data collection and preprocessing, and it also suppresses multipath components on each individual antenna.

AoA scenario, the asset with a tag that transmits a Bluetooth direction finding signal, which includes a constant tone extension packet (CTE). In this scenario, measurements made by the antenna arrays are used to determine the angle of the incoming signals.

AoD scenario, the client receives Bluetooth direction finding signals transmitted by one or several antenna arrays. In this case, the mobile client uses measurements of the incoming signal to compute the signal's direction of departure from the antenna array.

Ultra Wide Band (UWB) technology complements perfectly highly accurate indoor positioning for Real-Time Location Systems (RTLS), soon in u-blox portfolio.



The **ANT-B10** is a compact antenna board designed specifically for Bluetooth angle of arrival (AoA) direction finding systems. It features eight patch-antenna elements in an arrangement that offers optimal performance in the presence of multipath effects. To test the antenna u-blox provides the **XPLR-AOA-3** (includes C209 tag). The antenna boards, with a NINA-B411 Bluetooth LE module, apply an angle calculation algorithm to extract the direction to the tags. The angle is calculated by the u-connectEmbed software, running on the MCU in NINA-B411. No additional processing needed, the angle is delivered from the USB port of the antenna board.

The **u-locateTag** is a simple-to-use, credit card-sized tag for indoor positioning and direction-finding. Designed to be easily placed on assets or worn by individuals, u-locateTag features an ultra low-power chipset and fully supports the Bluetooth LE 5.1 standard for angle of arrival.

The **u-locateAnchor** is the first complete anchor point offering from u-blox. An integral part of the comprehensive u-locate solution for indoor positioning, **u-locateAnchor** offers great performance down to 10 cm accuracy.

The **u-locateTag** and the **u-locateAnchor** may be used together to provide a ready system. Installing, setting up, and configuring a complete indoor positioning system are complex and time-consuming tasks.

The u-locate solution has been designed with the goal of simplifying these as a priority.

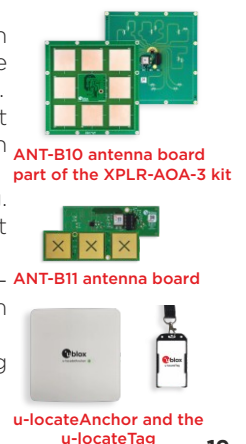

BLUETOOTH

Stand-alone short range radio modules

The **NINA Series** complying with the u-blox pin-compatibility concept, supports the design of one simple PCB layout that can be populated with either of the NINA modules - allowing for a quick, and with minimal software tweaks, change of the used connection technology. The choice between Bluetooth, WiFi or both now depending only on the specific use case requirements.

NINA Series, selected features:

- u-blox u-connectXpress** - pre-flashed u-blox application, allows immediate use of the module with reliable, approved by u-blox firmware, simple control via AT commands and added features like SPS (Serial Port Service) or GATT
- Open CPU** - allows to upload customized stacks and customer specific applications using third party APIs, allowing f.e. to use a NINA-B3 with Thread, Zigbee stacks, Matter, Apple HomeKit or AirFuel
- FOTA** - Firmware Over the Air update
- Secure boot** - the module boots up only in the presence of original certified software, preventing network hacks via compromised hardware

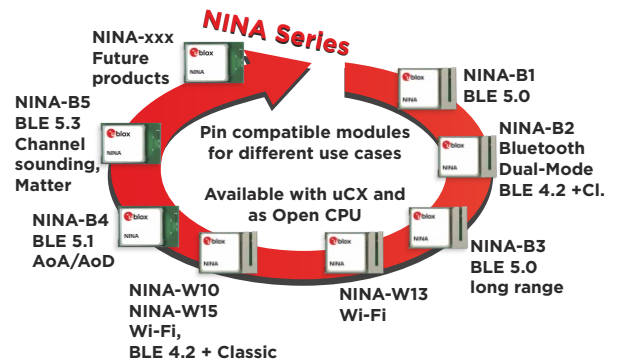

	Supply voltage [V]	Power consumption, Idle [mA] - connected*	Power consumption, Tx [mA]**	u-connectXpress	Open CPU	BLE qualification	Bluetooth Classic Wi-Fi: 2.4GHz (S), 2.4GHz & 5GHz (D)	Max range [meters]	Antenna type	UART	SPI	I2C	I2S	USB	GPIO pins	AD converters (ADC)	Throughput [Mbps]	AT commands support	Maximum connections	Point-to-Point	Extended Data Mode	uAccess point [stations]	BLE Serial Port (SPS)	Wi-Fi enterprise security	Secure boot	Mesh networking	FOTA	AoA/AoD	Matter
Bluetooth in SIP package																													
ANNA-B412	1.7-3.6	35 μ	0.8	●		v5.1		800 1400	I	●					19	8	0.8	●	8			●		●	●	●	●	●	
ANNA-B402	1.7-3.6	2.6 μ	6.0	●		v5.1		800 1400	I	●	●	●	●		33	8	1.4	●	20			●		●	●	●	●	●	
ANNA-B112	1.7-3.6	2.2 μ	5.3	●		v5.0		160 300	I	●					14		0.8	●	8			●		●	●	●	●		
ANNA-B112	1.7-3.6	2.2 μ	5.3	●		v5.0		160 300	I	●					26	8	1.4	●	20			●		●	●	●	●		
Bluetooth modules with u-connect or Open CPU																													
NINA-B111	1.7-3.6	2.2 μ	5.3	●		v5.0		350	E	●					7		0.8	●	8			●		●	●	●	●		
NINA-B111	1.7-3.6	2.2 μ	5.3	●		v5.0		350	E	●	●	●			19	8	1.4	●	20			●		●	●	●	●		
NINA-B112	1.7-3.6	2.2 μ	5.3	●		v5.0		300	I	●					7		0.8	●	8			●		●	●	●	●		
NINA-B112	1.7-3.6	2.2 μ	5.3	●		v5.0		300	I	●	●	●			19	8	1.4	●	20			●		●	●	●	●		
NINA-B221	3.0-3.6	95	130	●		v4.2	●	200	E	●					21		1.0	●	7			●		●	●	●	●		
NINA-B222	3.0-3.6	95	130	●		v4.2	●	200	I	●					21		1.0	●	7			●		●	●	●	●		
NINA-B301	1.7-3.6	1.3 μ	6.6	●		v5.0		1400	E	●	●	●	●		38	8	1.4	●	20			●		●	●	●	●		
NINA-B302/6	1.7-3.6	1.3 μ	6.6	●		v5.0		1400	I/P	●	●	●	●		38	8	1.4	●	20			●		●	●	●	●		
NINA-B311	1.7-3.6	1.3 μ	6.6	●		v5.0		1400	E	●	●				28		0.8	●	8			●		●	●	●	●		
NINA-B312/6	1.7-3.6	1.3 μ	6.6	●		v5.0		1400	I/P	●	●				28		0.8	●	8			●		●	●	●	●		
NINA-B400/1	1.7-3.6	1.3 μ	6.0	●		v5.1		1400	U/P	●	●	●	●		40	8	0.8	●	20			●		●	●	●	●		
NINA-B406	1.7-3.6	1.3 μ	6.0	●		v5.1		1400	I	●	●	●	●		40	8	0.8	●	20			●		●	●	●	●		
NINA-B410/1	1.7-3.6	1.3 μ	6.0	●		v5.1		1400	U/P	●					28		0.8	●	8			●		●	●	●	●		
NINA-B416	1.7-3.6	1.3 μ	6.0	●		v5.1		1400	I	●					28		0.8	●	8			●		●	●	●	●		
NINA-B501 ^{^A}	1.7-3.6	2.5 μ	4.6	●		v5.3		1400	E	●	●	●			29	16	1.4	●	24			●		●	●	●	●		
NINA-B506 ^{^A}	1.7-3.6	2.5 μ	4.6	●		v5.3		1400	I	●	●	●			29	16	1.4	●	24			●		●	●	●	●		
Rigado series Open CPU Bluetooth modules																													
BMD-380	1.7-5.5	1.5 μ	4.8	●		v5.0		500	I	●	●	●	●		44	12	1.4	●	20			●		●	●	●	●		
BMD-360	1.7-3.6	1.5 μ	4.6	●		v5.1		200	P	●	●	●			32	12	1.4	●	4			●		●	●	●	●		
BMD-350	1.7-3.6	1.5 μ	5.3	●		v5.0		190	I	●	●	●			32	12	1.4	●	20			●		●	●	●	●		
BMD-345	2.0-3.6	2.3 μ	12	●		v5.0		1000	U	●	●	●	●		44	12	1.4	●	20			●		●	●	●	●		
BMD-341	1.7-5.5	1.5 μ	4.8	●		v5.0		750	U	●	●	●	●		48	12	1.4	●	20			●		●	●	●	●		
BMD-340	1.7-5.5	1.5 μ	4.8	●		v5.0		350	P	●	●	●	●		48	12	1.4	●	20			●		●	●	●	●		
BMD-330	1.7-3.6	1.5 μ	4.6	●		v5.0		200	P	●	●	●			32	12	1.4	●	4			●		●	●	●	●		
BMD-301	1.7-3.6	1.5 μ	5.3	●		v5.0		400	U	●	●	●			32	12	1.4	●	20			●		●	●	●	●		
BMD-300	1.7-3.6	1.5 μ	5.3	●		v5.0		200	P	●	●	●			32	12	1.4	●	20			●		●	●	●	●		
R41Z	1.7-3.6	1.8 μ	6.1	●		v4.2		150	P	●	●	●			25	16	1.0	●	2			●		●	●	●	●		
Bluetooth modules with UWB																													
details released after printing date																													

[^] - production start scheduled after printing date ● - available in future FW version available
 Bluetooth Dual-Mode modules support SPP, DUN, PAN and GATT profiles, Single-Mode BLE modules support GATT
 * Power consumption in idle mode: Wi-Fi enabled, connected, Bluetooth Classic and BLE discoverable and connectable, average value
 ** Power consumption in Tx mode: All available technologies transmitting, average value
 A - also available as automotive, with CAN support Antenna type: I - internal antenna, P - antenna pin, U - U.FL connector for external antenna
 Shown sizes are for modules with internal antenna and external antenna connections (U.FL or Pin) ● - available in future FW version

WIFI, BLUETOOTH

Stand-alone short range radio modules



	Supply voltage [V]	Power consumption, idle [mA] - connected*	Power consumption, Tx [mA]**	u-blox uCX software	Open CPU	BLE qualification	Bluetooth Classic	Wi-Fi: 2.4GHz (S), 2.4GHz & 5GHz (D)	2.4GHz & 5GHz/6GHz (T)	Max range [meters]	Antenna type	UART	SPI	I2C	I2S	USB	GPIO pins	AD converters (ADC)	Throughput [Mbps]	TWT (Target Wake Time)	AT commands support	Maximum connections	Point-to-Point	Extended Data Mode	uAccess point [stations]	BLE Serial Port (SPS)	Wi-Fi enterprise security	Secure boot	Mesh networking	FOTA	AoA/AoD	Matter
Wi-Fi modules																																
NINA-W131	3.0-3.6	115	190	●			S		400	E	●					13	20			●	8	●	●	10	●	●						
NINA-W132	3.0-3.6	115	190	●			S		300	I	●					13	20			●	8	●	●	10	●	●						
Multiradio (Wi-Fi + Bluetooth) modules																																
NINA-W101	3.0-3.6	115	250	●		v4.2	S		400	E	●	●	●	●	●	20	4	25			8			10	●	●	●					
NINA-W102	3.0-3.6	115	250	●		v4.2	S		300	I	●	●	●	●	●	20	4	25			8			10	●	●	●					
NINA-W151	3.0-3.6	35	320	●		v4.2	S		400	E	●	●	●	●	●	13	13				7	●	●	10	●	●	●					
NINA-W152	3.0-3.6	35	320	●		v4.2	S		300	I	●	●	●	●	●	13	13				7	●	●	10	●	●	●					
IRIS-W101 [^] FV	3.15-3.45	45	375	●		v5.4	D		400	E	●	●	●	●	●	64	16	115	●		16			nd	●	●	●					
IRIS-W106 [^] FV	3.15-3.45	45	375	●		v5.4	D		300	P	●	●	●	●	●	64	16	115	●		16			nd	●	●	●					

FV- 10B - 16MB Flash, -30B - no Thread/Zigbee support,

DUAL CORE MODULES



Bluetooth modules																															
NORA-B100	1.7-5.5	1.3μ	5.3	●		v5.2			700	U	●	●	●	●	●	48	8	1.4			64						●	●	●	●	●
NORA-B101	1.7-5.5	1.3μ	5.3	●		v5.2			700	E	●	●	●	●	●	48	8	1.4			64						●	●	●	●	●
NORA-B106	1.7-5.5	1.3μ	5.3	●		v5.2			400	P	●	●	●	●	●	48	8	1.4			64						●	●	●	●	●
NORA-B120	1.7-3.6	2.3μ	22.3	●		v5.2			1700	U	●	●	●	●	●	46	8	1.4		●	64					●	●	●	●	●	●
NORA-B121	1.7-3.6	2.3μ	22.3	●		v5.2			1700	E	●	●	●	●	●	46	8	1.4		●	64					●	●	●	●	●	●
NORA-B126	1.7-3.6	2.3μ	22.3	●		v5.2			1500	P	●	●	●	●	●	46	8	1.4		●	64					●	●	●	●	●	●
NORA-B201 [^]	1.71-3.6	nd	nd	●		v5.4			nd	E	●	●	●	●	●	31	14	nd			nd					●	●	●	●	●	
NORA-B206 [^]	1.71-3.6	nd	nd	●		v5.4			nd	P	●	●	●	●	●	31	14	nd			nd					●	●	●	●	●	
ALMA-B201 [^]	1.7-3.6	nd	nd	●		v5.4			1400	E	●	●	●	●	●	64	14	nd			nd					●	●	●	●	●	
ALMA-B206 [^]	1.7-3.6	nd	nd	●		v5.4			1400	P	●	●	●	●	●	64	14	nd			nd					●	●	●	●	●	
Multiradio (Wi-Fi + Bluetooth) modules																															
NORA-W101	3.0-3.6	0.8	190	●		v5.0	S		500	E	●	●	●	●	●	20	12	150			10			10	●	●	●				
NORA-W106	3.0-3.6	0.8	190	●		v5.0	S		500	P	●	●	●	●	●	20	12	150			10			10	●	●	●				
NORA-W251AWS	3.0-3.6	nd	nd	●		v5.0	S		500	E	●	●	●	●	●	18		20		●	5			10	●	●					
NORA-W256AWS	3.0-3.6	nd	nd	●		v5.0	S		500	P	●	●	●	●	●	18		20		●	5			10	●	●					
NORA-W301/6	3.0-3.6	63	252	●		v5.3	D		500	E/P	●	●	●	●	●	21	12	150			nd			nd	●	●	●				
NORA-W361/6	3.0-3.6	60	252	●		v5.3	D		500	E/P	●	●	●	●	●	nd	nd	2.5		●	3			5	●	●	●				
NORA-W401/6 [^]	3.0-3.6	78	nd	●		v5.0	S		nd	E/P	●	●	●	●	●	20	12	150			nd			nd	●	●	●				
NORA-W451/6 [^]	3.0-3.6	nd	nd	●		v5.0	S		nd	E/P	●	●	●	●	●	20	12	150			nd			nd	●	●	●				

[^] - production start scheduled after printing date nd - information not available before printing date
 Bluetooth Dual-Mode modules support SPP, DUN, PAN and GATT profiles, Single-Mode BLE modules support GATT
 * Power consumption in idle mode: Wi-Fi enabled, connected, Bluetooth Classic and BLE discoverable and connectable, average value
 ** Power consumption in Tx mode: All available technologies transmitting, average value
 *** version only for EU, supports more channels from start up
 Antenna type: I - internal PIFA antenna, E - antenna pin, P - PCB antenna, U - U.FL connector for external antenna

Dual Core concept in NORA-B1

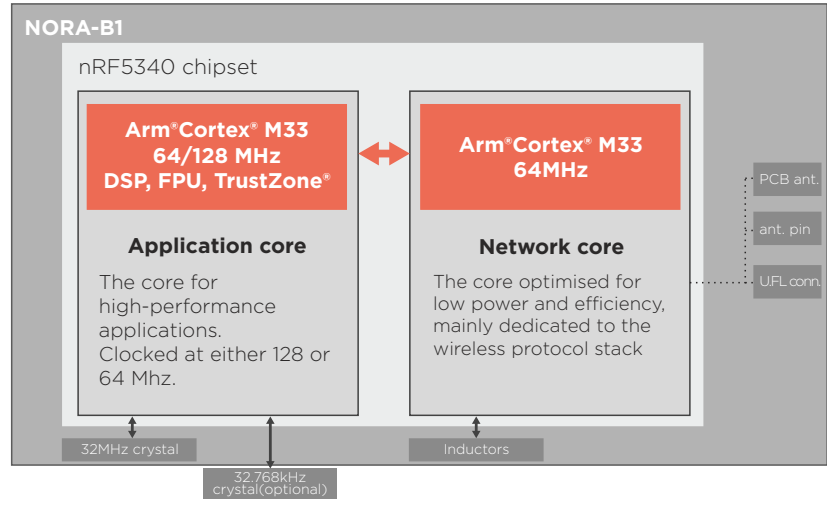

NORA-B1 series are small, stand-alone Bluetooth Low Energy, wireless microcontroller unit (MCU) modules that comply with the Bluetooth 5.2 specification. The modules are built on the Nordic nRF5340 chip as an open CPU solution where customer applications run on two Arm® Cortex®-M33 processor cores with integrated flash and RAM memory.

Features:

- Arm® TrustZone® and CryptoCell® 312 for enhanced security
- Multi-protocol support for Bluetooth 5.2, Bluetooth mesh, Matter, Thread, Zigbee, and NFC
- Support for Bluetooth Low Energy audio and Bluetooth Direction Finding
- Option with front-end module PA/LNA for extended range
- Extended temperature range up to 105 °C
- Global certification

Applications on the first core can run without being interrupted by network activity on the second



WI-FI, BLUETOOTH

Host-based short range radio modules

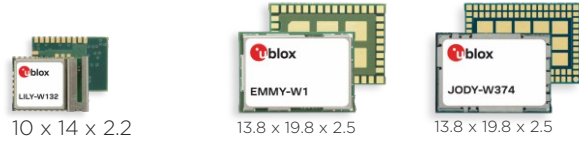

Module	Supply voltage [V]	Chipset	Bluetooth BR/EDR	Bluetooth Low Energy	Wi-Fi IEEE 801.11 (Wi-Fi4: 802.11n, Wi-Fi5: 802.11ac, Wi-Fi6: 802.11ax)	Bluetooth qualification	Wi-Fi: 2.4GHz (S), 2.4GHz & 5GHz (D), 2.4GHz & 5GHz/6GHz (T)	Antenna type	LTE Filter	High-speed UART for Bluetooth only	PCIe for Wi-Fi only	SDIO [version]	USB 2.0	PCM or I2S (Bluetooth audio)	Android/Linux support	RTOS support (via NXP MCU)	Micro Access Point [max stations]	AES hardware support	Wi-Fi direct	Simultaneous STA/AP on different channels	Factory calibrated RF	RF calibration in OTP	MAC address stored in module	WPA3	MIMO (MU=MU-MIMO only)	Matter
Wi-Fi modules																										
LILY-W131	1.7-3.6	NXP 88W8801			Wi-Fi4	S	1a				v2						8									
LILY-W132	1.7-3.6	NXP 88W8801			Wi-Fi4	S	int				v2						8									
LILY-W133	1.7-3.6	NXP 88W8801			Wi-Fi4	S	int				v2						8									
Multiradio (Wi-Fi + Bluetooth) modules for automotive applications																										
EMMY-W161	3.0-3.6	NXP 88W8887A			Wi-Fi5	v4.2	D 1p				v3						10									
EMMY-W163	3.0-3.6	NXP 88W8887A			Wi-Fi5	v4.2	D 2p				v3						10									
EMMY-W165	3.0-3.6	NXP 88W8887A			Wi-Fi5	v4.2	D 1p				v3						10									
JODY-W163	3.2-4.8	CYW89359			Wi-Fi5	v5.0	D 2p				v3						10									
JODY-W164	3.2-4.8	CYW89359			Wi-Fi5	v5.0	D 2p										10									
JODY-W167	3.2-4.8	CYW89359			Wi-Fi5	v5.0	D 3p										10									
JODY-W174	3.2-4.8	CYW89359			Wi-Fi5	v5.1	D 2p										12									
JODY-W263	2.8-5.5	NXP 88W8987			Wi-Fi5	v5.2	D 2p				v3						8									
JODY-W354	3.14-3.46	NXP AW690			Wi-Fi6	v5.3	D 2p										64									
JODY-W374	3.14-3.46	NXP Q9098			Wi-Fi6	v5.3	D 2p				v3						64									
JODY-W377	3.14-3.46	NXP Q9098			Wi-Fi6	v5.3	D 3p				v3						64									
JODY-W487^	3.0-3.6	IFX 89570			Wi-Fi6E	v5.3	T 3p				v3						16								MU	
JODY-W562^	3.14-3.46	NXP AW611			Wi-Fi6	v5.4	D 2p				v3						16									MU
JODY-W682^	3.14-3.46	NXP AW693			Wi-Fi6/6E	v5.3	T 2p										64									
JODY-W683^	3.14-3.46	NXP AW693			Wi-Fi6/6E	v5.3	T 3p										64									

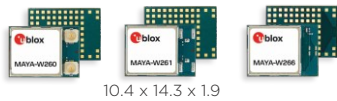

10.4 x 14.3 x 1.9

Multiradio (Wi-Fi + Bluetooth) modules for commercial applications																										
Module	Supply voltage [V]	Chipset	Bluetooth BR/EDR	Bluetooth Low Energy	Wi-Fi IEEE 801.11 (Wi-Fi4: 802.11n, Wi-Fi5: 802.11ac, Wi-Fi6: 802.11ax)	Bluetooth qualification	Wi-Fi: 2.4GHz (S), 2.4GHz & 5GHz (D), 2.4GHz & 5GHz/6GHz (T)	Antenna type	LTE Filter	High-speed UART for Bluetooth only	PCIe for Wi-Fi only	SDIO [version]	USB 2.0	PCM or I2S (Bluetooth audio)	Android/Linux support	RTOS support (via NXP MCU)	Micro Access Point [max stations]	AES hardware support	Wi-Fi direct	Simultaneous STA/AP on different channels	Factory calibrated RF	RF calibration in OTP	MAC address stored in module	WPA3	MIMO (MU=MU-MIMO only)	Matter
MAYA-W160	3.0-3.6	NXP IW416			Wi-Fi4	v5.2	D 2u				v3						8									
MAYA-W161	3.0-3.6	NXP IW416			Wi-Fi4	v5.2	D 2p				v3						8									
MAYA-W166	3.0-3.6	NXP IW416			Wi-Fi4	v5.2	D int				v3						8									
MAYA-W260	3.0-3.6	NXP IW611			Wi-Fi6	v5.2	D 2u				v3						16								MU	
MAYA-W261	3.0-3.6	NXP IW611			Wi-Fi6	v5.2	D 2p				v3						16								MU	
MAYA-W266	3.0-3.6	NXP IW611			Wi-Fi6	v5.2	D int				v3						16									
MAYA-W271	3.0-3.6	NXP IW612			Wi-Fi6	v5.2	D 2p				v3						16								MU	
MAYA-W276	3.0-3.6	NXP IW612			Wi-Fi6	v5.2	D int				v3						16									
MAYA-W331^	3.13-3.46	CYW55511			Wi-Fi6	v5.4	S 2p				v3						16								MU	
MAYA-W333^	3.13-3.46	CYW55511			Wi-Fi6	v5.4	S 1p				v3						16									
MAYA-W336^	3.13-3.46	CYW55511			Wi-Fi6	v5.4	S int				v3						16									
MAYA-W361^	3.13-3.46	CYW55512			Wi-Fi6	v5.4	D 2p				v3						16								MU	
MAYA-W363^	3.13-3.46	CYW55512			Wi-Fi6	v5.4	D 1p				v3						16									
MAYA-W366^	3.13-3.46	CYW55512			Wi-Fi6	v5.4	D int				v3						16									
MAYA-W381^	3.13-3.46	CYW55513			Wi-Fi6E	v5.4	T 2p				v3						16								MU	
MAYA-W383^	3.13-3.46	CYW55513			Wi-Fi6E	v5.4	T 1p				v3						16									
MAYA-W386^	3.13-3.46	CYW55513			Wi-Fi6E	v5.4	T int				v3						16									

^ - production start scheduled after printing date □ - Linux drivers in source code ○ - on request
 1p = 1 antenna pin for combined Bluetooth and Wi-Fi 1a = 1 pin for external antenna
 2p = 2 antenna pins, one each for Bluetooth and Wi-Fi 2a = 2 pins for 2 external antennas
 3p = 3 pins, 2 for Wi-Fi and 1 for Bluetooth antenna 2u = 2 U.F.L connectors, one each for Bluetooth and Wi-Fi

SHORT RANGE TOOLS

The **short range kits** are equipped with a J-Link debugger and a processor for own application development - designed for use with Arm® Mbed™ or radio chipset manufacturers SDK. They are complete starter kits that allow quick prototyping of a variety of Bluetooth low energy and Wi-Fi sensor applications for Internet of Things.

s-center, s-center 2 - dedicated software to connect with u-blox ANNA, NINA, NORA, ODIN Wi-Fi and Bluetooth products, providing intuitive tools to test the unique functionalities of the modules.



EVK-MAYA-W16



EVK-IRIS-W1

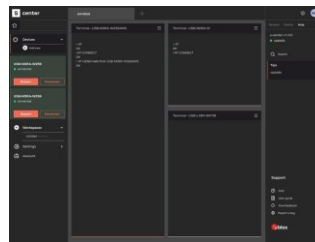

s-center 2

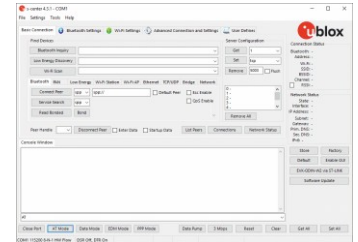

s-center

M.2 CARDS

The u-blox M.2 cards combine the maximum performance of the modules with flexible, easy to use M.2 card form. The used industry standard M.2 type 2230 Key E and U.FL connectors, or integrated PCB antennas, reduce design effort.

The module featured on the card, like all u-blox modules, undergoes extensive qualification tests to ensure reliability over its lifetime. The cards are compatible with NXP i.MX development boards, and are also available in single quantity sets with antennas, and as simple evaluation kits (f.e. EVK-MAYA-...)

M2-MAYA-W166 integrates antenna for WiFi and Bluetooth, the others include U.FL connectors:
M2-MAYA-W161/W271/W381[^], **M2-JODY-W263/W562[^]/W683[^]** - one for WiFi, one for Bluetooth
M2-JODY-W377 - two for WiFi (2x2 MIMO), one for Bluetooth

[^] - production start scheduled after printing date



U-BLOX WIRELESS SECURITY

The Internet of Things concept is the road the whole world is taking, but in a connected world security breach prevention is one of the most important aspects of proper system design. u-blox, as manufacturer of reliable industrial, professional products, provides exceptional security built into their solutions. Protect your application by using u-blox GNSS, Cellular or Short-range modules.



Threats	Principle	The u-blox approach
Modifications to the way that u-blox and customers' products work	Secure Boot Secure FW upgrades Secure interfaces Secure APIs	u-blox products are secured against security threats originating from attacking the module behaviour, man-in-the-middle and replay attacks Bootloader accepts only authenticated Software
Changing the data as it flows through the system	Secure communications TLS (Transport Layer Security) SSL (Secure Socket Layer) EAP-TLS for Wi-Fi stations Secure Simple pairing	u-blox AssistNow service cannot be used to attack the GNSS receivers Encrypted and authenticated via certificate connections for Wi-Fi and Cellular modules EAP-TLS Wi-Fi modules will connect to APs only with a trusted certificate BLE secure connections use Elliptic Curve Diffie Hellman (ECDH) for key generation
Unauthorised systems taking control of u-blox products	Spoofing and jamming protection Protected management frames (802.11w)	Protection against malicious attacks, also at the antenna side Management action frames are protected from both eavesdropping and forging

Secure boot will not allow the module to run with malicious software

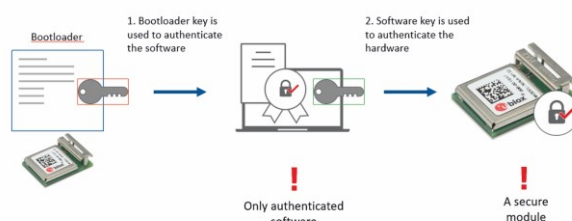

GNSS ANTENNAS

THE MOST POPULAR VERSIONS

ME4D01MP



ANN-MB5



- I Active L1 GNSS antenna
- I Magnetic version, sticker option
- I RG174 cable with the type of connector upon request
- I Dimensions (mm) 41 x 34 x 13.7
- I Operating temp. -40°C to +85°C
- ANN-MB5**
- I Multi-band (L1/L5) active GNSS antenna
- I 3m cable and SMA connector
- I Dimensions (mm) 49.1 x 46.1 x 15.9

ANN-MB/-MB1/-MB2



- I **Active multi-band L1, L2/E5 (MB), L1, L5/E5a/B2a/NavIC (Mb1) or L1/L2/L5/E6/B3/L-corrections**
- I GNSS antennas with excellent price performance ratio
- I GPS, GLONASS, Galileo, and BeiDou
- I Fast and easy antenna solution for high precision applications
- I Many mounting and connector options
- I **details on page 7**

MEF0301P



- I Passive GNSS antenna
- I Gain -3.9 dBi
- I Efficiency -76%
- I cable with the type of connector upon request
- I Dimensions (mm) 55.4 x 12.4 x 0.2
- I Operating temperature -40°C to +85°C
- I **Flexible**

ME6600B



- I 1x GPS (ME6600B)
- I 1x GPS+GLONASS (ME6600BG)
- I 1x 2G, 3G
- I **Vandal proof**
- I **Screw mount**
- I screw diameter M14
- I Dimensions (mm) Ø 77 x H 15
- I Operating temperature -40°C to +85°C

ME7041BGa



- I **2 x 4G LTE/3G/2G MIMO**
- I **1 x GPS/GLONASS/Galileo**
- I Vandal proof
- I Screw mount
- I Dimensions (mm) Ø 96 x H 90
- I Operating temperature -40°C to +85°C
- I Versions with additional ISM connections available

ME4441GP



- I **1x 4G LTE/3G/2G**
- I **1x GPS/GLONASS/Galileo**
- I Dimensions (mm) 161 x 76.5 x 16
- I Cellular efficiency -70%
- I GNSS gain 23 dB@3 V, 24 dB@ 5 V
- I Operating temperature -40°C to +85°C

ACTIVE PATCH

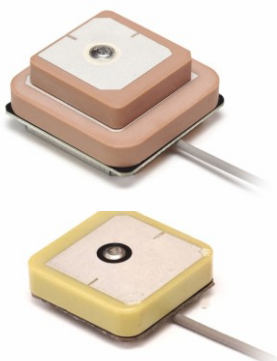

Active patch antennas are a perfect solution for devices where an internal antenna is needed, but a RF signal path SMD design is challenging.

- I **Available in various sizes**
- I 18 x 18 mm 13 x 13 mm
- I 25 x 25 mm
- I **Pre-filter and mid-filter versions** for saturation protection or low noise figure
- I **Two LNA gain possibilities**
- I 14 dB for low power consumption
- I 28 dB for weak signal environments
- I cable length and connector upon request
- I **GPS or GPS/GLONASS versions**
- I **Multi-band stacked patches available**

I Active L1/L2/L5 Full GNSS Bands for RTK applications

- I **MIL-STD-810G**
- I Gain 34.5 dB
- I **Ground plane independent**
- I Dimensions (mm) Ø 80 x H 40

M10HCT-A-SMA



I Active quadrifilar helix antenna for RTK applications

- I Concurrent GNSS reception on L1: GPS, GLONASS, Galileo, BeiDou
- L2: GPS L2C, GAL E5B, GLO L3OC
- L5: GPS (M8HCT-A-SMA)
- L-Band (M9HCT-A-SMA)
- I Rugged IP-67 rating with SMA
- I Ultra lightweight - 25 grams
- I Dimensions (mm) Ø 35 x H 57

M7HCT-A-SMA



I High performance passive GPS or GPS/GLO antenna

- I Very low axial ratio
- I IP-67 mounted and unmounted
- I Ultra light weight - 10 grams
- I Ground plane independent
- I Dimensions (mm) Ø 18.5 x H 38
- I SMA connector
- I **Internal version available: Ø 12.85 x H 24.30, only 2g weight**

M1575HCT-22P-SMA (GG)



I Active L1/L2 GPS/GLONASS bands

- I Rugged IP-67 rating
- I Superior out-of-band rejection
- I 50 V/m jamming resistant
- I Very low noise figure
- I SMA connector
- I Dimensions (mm) Ø 30 x H 51
- I Ground plane independent
- I **GIS & RTK applications**
- I Ultra light weight - 24 grams

M1227HCT-A2-SMA



I Passive GPS/GLONASS antenna

- I Very low axial ratio
- I IP-67 mounted
- I Ultra light weight - 12 grams
- I Ground plane independent
- I Dimensions (mm) Ø 18.5 x H 48

M1516HCT-P



I High performance Active GPS antenna

- I Very low axial ratio
- I IP-67 mounted and unmounted
- I Ultra light weight - 10 grams
- I Ground plane independent
- I Dimensions (mm) Ø 18.5 x H 38
- I SMA connector

M1575HCT-15A-SMA



GNSS PATCH

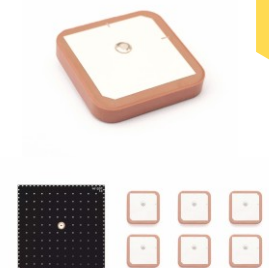

Microstrip GNSS patch type antennas are offered in several sizes, to fit almost any application.

Starting from **13 mm x 13 mm** for very small GNSS receivers and ending with **25 mm x 25 mm**. SMD and through-hole mounting options are available.

Engineering kits (tuning kits) contain 6 pcs of the antennas, but with different resonance frequencies, which allows a selection of an antenna tuned to a particular environment (housing and other components have a major impact on the efficiency of GNSS antennas).



CELLULAR ANTENNAS

THE MOST POPULAR VERSIONS

ME0B04



I Standards 2G and 3G
I VSWR -2.2:1, -2.4:1
I Efficiency (%) -70.6, -56.4
I Peak Gain (dBi) -2.9, -1.8
I Dimensions (mm) 44 x 19.1 x 9
I Operating temperature -40 °C to +85 °C

I Standards 2G, 3G and 4G
I VSWR -2.8:1, -2.5:1, -2.7:1
I Efficiency (%) -58, -52, -41.9
I Peak Gain (dBi) -3.0, -2.3, -0.7
I Dimensions (mm) 208.3 x Ø16
I Operating temperature -40 °C to +85 °C

ME2124K-B07H



ME3704M



I Standards 2G and 3G
I VSWR -1.6:1, -1.8:1
I Efficiency (%) -49, -28
I Peak Gain (dBi) -1.7, -0.3
I Dimensions (mm) 30.9 x 71.5
I Operating temperature -40 °C to +85 °C
I Magnetic

I Standards 2G, 3G and 4G
I VSWR -2.4:1, -1.6:1, -2.2:1
I Efficiency (%) -62, -75, -50
I Peak Gain (dBi) -0.4, -2.6, -1.3
I Dimensions (mm) 171 x 38 x 13.8
I Operating temperature -40 °C to +85 °C
I Magnetic version available

MEW0124



ME5004PL



I Standards 2G and 3G
I VSWR -1.5:1, -1.4:1
I Efficiency (%) -52, -43
I Peak Gain (dBi) -3.5, -4.6
I Dimensions (mm) 126.5 x 22 x 6.7
I Operating temperature -40 °C to +85 °C
I Adhesive mount

I Standards 2G, 3G and 4G
I VSWR -2.0:1, -1.5:1, -1.8:1
I Efficiency (%) -53, -52, -41
I Peak Gain (dBi) -2.0, -4.1, -4.1
I Dimensions (mm) 117.4 x 12.5 x 6.5
I Operating temperature -40 °C to +85 °C
I Adhesive mount

ME5224P



MEW0304



I Standards 2G and 3G
I VSWR -2.1:1, -1.6:1
I Efficiency (%) -30, -59
I Peak Gain (dBi) -1.3, -2.0
I Dimensions (mm) 113 x 10
I Hinge
I Operating temperature -40 °C to +85 °C

I Standards 2G, 3G and 4G
I VSWR -3.1:1, -1.7:1, -1.5:1
I Efficiency (%) -58, -67, -74
I Peak Gain (dBi) -0.1, -2.9, -4.6
I Dimensions (mm) Ø 10 x 71
I Hinge
I Operating temperature -20 °C to +65 °C

MEW1024



ME3104M



I Standards 2G and 3G
I VSWR -1.6:1, -1.5:1
I Efficiency (%) -48.6, -34.5
I Peak Gain (dBi) -2.2, -3.0
I Dimensions (mm) Ø 31 x 248.4
I Operating temperature -40 °C to +85 °C

I Standards 2G, 3G and 4G
I VSWR -2.8:1, -1.5:1, -1.7:1
I Efficiency (%) -54.8, -67.5, -70.1
I Peak Gain (dBi) -1.2, -4.1, -4.2
I Dimensions (mm) 40 x 7 x 3
I Operating temperature -40 °C to +85 °C

MEE18



MEE017



I Standards 2G and 3G
I VSWR -3.3:1, -1.8:1
I Efficiency (%) -67.5, -70.8
I Peak Gain (dBi) -2.2, -2.2
I Dimensions (mm) 26 x 7.6 x 3
I Operating temperature -40 °C to +85 °C

I Standards 2G, 3G and 4G
I VSWR -1.5:1, -1.8:1, -2.1:1
I Efficiency (%) -45, -48, -48
I Peak Gain (dBi) -0.3, -1.5, -2.8
I Dimensions (mm) 89.7 x 14.1 x 0.8
I Operating temperature -40 °C to +85 °C

MEP0624P



MEF0304P



I Standards 2G and 3G
I VSWR <=2.4:1, <=1.5:1
I Efficiency (%) -41, -61
I Peak Gain (dBi) -1, -2.1
I Dimensions (mm) 70.4 x 26.4 x 0.1
I Operating temperature -40 °C to +85 °C
I Flexible antenna

I 1x 2G and 3G
I 1x WiFi, BT, ZigBee, ISM (2.4GHz)
I 1x GPS/QZSS/Galileo/GLONASS
I 1x IRIDIUM
I Peak Gain (dBi) -1.8, -2.3, -2.5, 28 @ 2.7 V, -4.5
I Heavy Duty antenna
I Screw mount
I Dimensions (mm) Ø 146 x 31.5
I Operating temperature -40 °C to +85 °C

ME6551BG



MEP0104P



I Standards 2G and 3G
I VSWR <=2:1, <=2.6:1
I Efficiency (%) -45, -60
I Peak Gain (dBi) -0.5, -3
I Dimensions (mm) 75 x 25 x 0.8
I Operating temperature -40 °C to +85 °C

I 2x 2G, 3G and 4G
I 2x WiFi, BT, ZigBee, ISM (2.4GHz)
I 1x GPS/QZSS/Galileo/GLONASS
I Heavy Duty antenna
I For 43,2mm Mast Mounting
I Dimensions (mm) Ø 96 x H 90
I Operating temperature -40 °C to +85 °C

ME7050JGa



ISM ANTENNAS

THE MOST POPULAR VERSIONS

MEOA02-2.4



I Standards WiFi, BT, ZigBee, ISM
I Frequency 2.4 GHz ISM
I VSWR -4.1:1
I Efficiency (%) -61
I Peak Gain (dBi) -3.5
I Dimensions (mm) 44 x 9.6
I Operating temperature -40 °C to +85 °C

I Standards Sigfox/LoRa/
 ZigBee/RFID/LPWA/ISM/UHF
I Frequency 868 MHz ISM
I VSWR -1.8:1
I Efficiency (%) -69.3
I Peak Gain (dBi) -1.2
I Dimensions (mm) 44 x 19.1 x 9
I Operating temperature -40 °C to +85 °C

MEOB15-868



ME3702M



I Standards WiFi, BT, ZigBee, ISM
I Frequency 2.4 GHz ISM
I VSWR -1.2:1
I Efficiency (%) -4.3
I Magnetic
I Peak Gain (dBi) -1.6
I Dimensions (mm) Ø 31 x 71.5
I Operating temperature -40 °C to +85 °C

I Standards ZigBee, ISM,
 SIGFOX, LoRa
I Frequency 868 MHz ISM
I VSWR -1.4:1
I Efficiency (%) -37.0
I Peak Gain (dBi) --0.3
I Dimensions (mm) 50 x Ø16
I Operating temperature -40 °C to +85 °C
I Through hole mount

ME1015-868



MEW0302-2.4



I Standards WiFi, BT, ZigBee, ISM
I Frequency 2.4 GHz ISM
I VSWR -1.9:1
I Efficiency (%) -62
I Peak Gain (dBi) -1.5
I Dimensions (mm) 113 x 10
I Operating temperature -40 °C to +85 °C
I Hinge

I Standards ZigBee, ISM,
 SIGFOX, LoRa
I Frequency 868 MHz ISM
I VSWR -1.3:1
I Efficiency (%) -64.5
I Magnetic
I Peak Gain (dBi) -2.6
I Dimensions (mm) Ø 30.9 x 91
I Operating temperature -40 °C to +85 °C

ME3915M-868



MEF0202P



I Standards WiFi, BT, ZigBee, ISM
I Frequency 2.4/5.0 GHz ISM
I VSWR -1.2:1, -1.5:1
I Efficiency (%) -76.3, -74.7
I Peak Gain (dBi) -4.4, -6.7
I Dimensions (mm) 30 x 30 x 0.2
I Operating temperature -40 °C to +85 °C
I Flexible antenna

I Standards ZigBee, ISM,
 SIGFOX, LoRa
I Frequency 868 MHz ISM
I VSWR -1.2:1
I Efficiency (%) -59.1
I Peak Gain (dBi) -2.6
I Dimensions (mm) 117.4 x 12.5 x 6.5
I Operating temperature -40 °C to +85 °C
I Flexible antenna

ME5215P-868



MEP0102



I Standards WiFi, BT, ZigBee, ISM
I Frequency 2.4/5.0 GHz ISM
I VSWR -2.4:1, -2.2:1
I Efficiency (%) -53, -64
I Peak Gain (dBi) -3.2, -5.0
I Dimensions (mm) 16.4 x 5.4 x 0.4
I Operating temperature -40 °C to +85 °C

I Standards ZigBee,
 ISM, SIGFOX, LoRa
I Frequency 868 MHz ISM
I VSWR -1.9:1
I Efficiency (%) -32.7
I Peak Gain (dBi) -0.8
I Dimensions (mm) 40.0 x 7.0 x 0.2
I Operating temperature -40 °C to +85 °C

MEF0115P



MEW035



I Standards WiFi, BT, ZigBee, ISM
I Frequency 2.4/5.0 GHz ISM
I VSWR -2.1:1, -2.8:1
I Efficiency (%) -35, -60
I Peak Gain (dBi) -1.4, -3.2
I Dimensions (mm) 76 x Ø 10
I Operating temperature -40 °C to +85 °C

I Standards ISM, LoRa
I Frequency 433 MHz ISM
I VSWR -1.5:1
I Peak Gain (dBi) --10.3
I Dimensions (mm) 12 x 4 x 1.6
I Operating temperature -40 °C to +85 °C

MEE15b



MEWIFI12



I Standards WiFi, BT, ZigBee, ISM
I Frequency 2.4/5.0 GHz ISM
I VSWR -1.6:1, -1.8:1
I Efficiency (%) -60, -63
I Peak Gain (dBi) -7.2, -5.2
I Dimensions (mm) 104 x 104 x 90
I Operating temperature -40 °C to +85 °C
I Mast mount

I Standards
WiFi, Bluetooth, ISM
I Frequency 2400-2500 MHz
 5700-5870 MHz
I Waterproof
I Various mounting options available
I Efficiency over 60%

MAXTENA MPA-254-WIFI

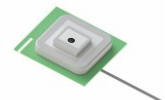

ME7002Bc



I Standards WiFi, BT, ZigBee, ISM
I 4 x 2.4/5.0 GHz ISM MIMO
I VSWR -1.9:1, -1.6:1
I Efficiency (%) -58, -64
I Peak Gain (dBi) -5.6, -5.5
I Dimensions (mm) Ø 96 x H 90
I Operating temperature -40 °C to +85 °C

MAXTENA MEA-2400-UWB-SM



MAXTENA MEA-2400-MM



Bulgaria@microdis.net
Croatia@microdis.net
Czech@microdis.net
Estonia@microdis.net
Germany@microdis.net
Hungary@microdis.net
Latvia@microdis.net
Lithuania@microdis.net
Poland@microdis.net
Romania@microdis.net
Serbia@microdis.net
Slovakia@microdis.net
Slovenia@microdis.net
Turkiye@microdis.net*
Ukraine@microdis.net



Europe@microdis.net

*Electromechanical Competence Centre for Turkiye

Currently the Microdis Group employs over 100 people, with a large number of electronic engineers, mostly involved in sales and application support.

As a company with an extensive experience in the distribution of electronic components, and a purchasing center in Germany for many years, we are able to offer almost any product from a wide variety of electronic components. We offer also the production of cable harnesses and programming of crystal oscillators for a customised frequency. Cooperation with a catalogue distributor provides fast deliveries (2 days) of a wide range of catalogue products. We have certificates of quality management DIN EN ISO 9001:2015 for the distribution of electronic components.



AAEON	Industrial computers and panels	www.aaeon.com
AEGID	RFID systems and transponders	www.aegid.de
ASROCK INDUSTRIAL	3.5" & mini-ITX industrial boards	www.asrockind.com
BRIGHTTEK	Power, THT and chip LEDs and LED modules	www.brighttekeurope.com
CAMDENBOSS	Interconnect components, electronic housings, 19" cabinets	www.camdenboss.com
EPSON	Crystals, oscillators, filters and sensors	www.epsondevice.com
	Programmable oscillator web-shop	epson.microdis.net
FISCHER CONNECTORS	Military, medical and industrial connectors	www.fischerconnectors.com
FISCHER ELEKTRONIK	Heatsinks, connectors, 19" and case technology	www.fischerelektronik.de
GERSYS	Railway computers	www.gersys.de
GCT	SIM-Holders, memory card connectors, USB connectors	www.gct.co
IYAMA	Large Format Displays	www.iiyama.com
ISOCOM	Optocouplers, optoswitches	www.isocom.com
JST	Signal connectors	www.jst.de
LEAR	Automotive and white goods connectors	www.lear.com
MAXTENA	GPS, Galileo, Glonass, Iridium antennas	www.maxtena.com
MECAL	Machines and systems for wire crimping	www.mecal.com
MEDER	Reed switches, sensors and relays	www.meder.com
METZ CONNECT	Terminal block connectors - screw, spring and pins	www.metz-connect.com
NEOUSYS TECHNOLOGY	Wide-temperature fanless computers	www.neosys-tech.com
NEXCOM	Industrial computers and panels	www.nexcom.com
NEXAIOT	Industry 4.0 computer solutions	www.nexaiot.com
RICARDO & BARBOSA	Crimping tools like standard applicators and heavy duty dies for loose terminals	www.ricardo-barbosa.com
	MIL & Space grade Frequency control solutions	www.rakon.com
RAKON	Automotive and white goods connectors	www.groupe-savoy.fr
SAVOY TECHNOLOGY	Displays & projectors	www.sharpnecdisplays.eu
SHARP/NEC	Modules: GNSS, Cellular, WiFi, Bluetooth, ZigBee, Thread, Matter, UWB, NFC; Services; GNSS antennas	www.u-blox.com
U-BLOX	Hand tools for crimping, pneumatic presses	www.wezag.de
WEZAG		

